

KNAUF

كناوف



2019

ASTM DRYWALL PARTITIONS





KNAUF Group

Knauf was founded as a family-owned company by the brothers Karl and Dr. Alfons Knauf in 1932 in Germany.

The Knauf Group is present in its native country with numerous companies that manufacture innovative products geared to the applications and various requirements of the modern building materials market.

In their capacity as specialists for problem solutions, these firms, which operate mainly in the dry construction and plastering sectors, market their products worldwide.

Operating more than 150 production sites worldwide, today, Knauf is one of the world's leading manufacturers of building materials.

Knauf has a workforce of 23,000 in 40 countries and in 2012 the company generated sales was approximately 7 billion Euros.

Knauf LLC is the regional subsidiary for the Knauf Group in the Middle East, providing technical and commercial support, specification, design and training services.



Contents

Introduction	04 - 05
SYSTEM / PRODUCT TESTING AND PERFORMANCE	06 - 07
KNAUF PARTITIONS	08 - 10
SYSTEMS OVERVIEW	11
KW A111 - CONNECTIONS AND JOINTS (SPACING & HEIGHT)	12 - 13
KW A111 - SYSTEMS BUILD-UP	14 - 15
KW A112 - CONNECTIONS AND JOINTS (SPACING & HEIGHT)	16 - 17
KW A112 - SYSTEMS BUILD-UP	18 - 19
KW A115 - CONNECTIONS AND JOINTS (SPACING & HEIGHT)	20 - 21
KW A115 - SYSTEMS BUILD-UP	22 - 23
KW A116 - CONNECTIONS AND JOINTS (DEFLECTION HEAD DETAILS)	24 - 25
KW A116 - SYSTEMS BUILD-UP	26 - 27
KW A/S115 - CONNECTIONS AND JOINTS (Staggered Stud System) (SPACING & HEIGHT)	28 - 29
KW A/S115 - SYSTEMS BUILD-UP (Staggered Stud System)	30 - 31
KNAUF SHAFTWALL - (Introduction)	32 - 33
KSW A60 (Shaftwall Single Layer)	34 - 35
KSW A120 (Shaftwall Double Layer)	36 - 37
SHAFTWALL - SYSTEMS BUILT-UP (KSW A60 & KSW A120)	38 - 39
GENERAL REQUIREMENTS (CONTROL JOINTS)	40 - 41
Training (Installation steps)	42 - 43
General Requirements (Studs positioning)	44 - 45
Framing (Fixing loads / Cantilever loads)	46 - 47
Door openings (Window openings)	48 - 49
Cladding of boards (Boards fixing)	50 - 51
Curved partitions (Joint treatment)	52 - 53
BOARDS	54 - 55
PROFILES (COMPONENTS AND ACCESSORIES)	56 - 57
COMPANY'S CERTIFICATION	58
Civil Defense Approval	59

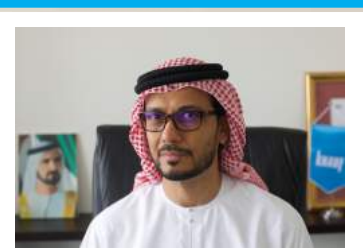

To Our Valued Customers,

Knauf is one of the leading voices in sourcing locally and manufacturing products that are truly “Made in UAE” as well as enabling collaboration with the major industry leaders towards technological advancements in manufacturing and logistics. This has made us fully equipped to efficiently cater the needs, wants and preferences of our valued customers and clients who over time have become a part of our big family.

Our commitment towards building environmentally responsible and economically sustainable products locally have been applauded, recognized and certified by esteemed UAE government authorities such as Ministry of Interiors, Civil Defense, Central Laboratory, Quality and Conformity Council.

Headquartered in Dubai, UAE, Knauf shows its customer service excellence and commitment in the Middle East and India. We ensure that the demand meets the supply, the first time and every time by utilizing our full range of flexibility and potential of our production facilities, human resources, technical expertise, logistics and cutting edge digitalisation, thereby facilitating rapid growth and development in the region.

Here is a highlight of some of Knauf’s products, systems and services:

- Gypsum based high performance drywall building materials, system and accessories.
- ASTM certified products & systems – Ceiling, Partition, Wall Lining and Cinema System.
- Knauf Aquapanel cement boards for interior, exterior and universal usages.
- Knauf Aquapanel Exterior Systems (Exterior walls, cladding and ceiling).
- Knauf Heraklith’s acoustic designs for Interior and Exterior in ceiling & partition systems.
- Knauf Integral’s Knauf GIFA Floor, sheet-paneled access floors systems.
- Fire and acoustic rated sealants and materials.
- Multi- Purpose Joint compounds.
- Engineering and technical consultancy for architects, consultants, etc.
- Knauf Training Academy: Hands-on training.

Knauf’s high performing, innovative systems are fast and easy to install and are manufactured to meet ASTM, EN-BS and DIN Standards, to meet any client requirements. Our dedicated Training Academy is committed to making sure that all our end users are up to date of our system.

Quality, sustainability, health and safety are central to our vision, actions towards our people and the local communities ensuring every product that comes out of the line is rigorously tested, certified, approved and socio- environmentally responsible while producing them. Our ISO 9001 (Quality Management System), 14001 (Health, Environment and Safety), 18001 (OHSAS) and 50001 (Energy Management) certifications are a testament to our commitment to the same.

Our four dimensional core values called K-Values: Partnership, Commitment, Entrepreneurship and Menschlichkeit (“the human touch” in German) are the key drivers of our camaraderie and operational excellence throughout our multi-cultural organizational structure. It is this passion that subsequently reflects in our products and customer service excellence as well.

Thank you for being part of this big family and Let’s Build the Future together.

Amer Bin Ahmed
Managing Director
Knauf Middle East & India

Global Board of Director



Board of Director



Intertek Certified



ISO Certified



Introduction

WHAT IS GYPSUM BOARD?

Gypsum board is the generic name for a family of panel products that consist of a noncombustible core, composed primarily of gypsum, and a paper surfacing on the face, back and long edges. Gypsum board is one of several building materials covered by the umbrella term “gypsum panel products.” All gypsum panel products contain gypsum cores; however, they can be faced with a variety of different materials, including paper and fiberglass mats.

Gypsum board is often called drywall, wallboard, or plasterboard. It differs from other panel-type building products, such as plywood, hardboard, and fiberboard, because of its noncombustible core and paper faces. When joints and fastener heads are covered with a joint compound system, gypsum wall board creates a continuous surface suitable for most types of interior decoration.

Ease of installation

Knauf Gypsum board building systems are easy to install for several reasons. Gypsum board panels are relatively large compared to other materials. They come in 48 Inch wide sheets and various lengths, so they quickly cover large wall and ceiling areas. Knauf Gypsum board assemblies require only a few tools for their construction. Gypsum board can be cut with either a utility knife or a variety of saws, and it can be attached using the Knauf drywall TN or TB screws, it can also be adhesively attached to many substrates. Gypsum board is a lightweight material. Two workers can easily handle most panels and cover large areas in very short time periods. Gypsum board is easily finished using either a few hand tools or relatively modest machines. Gypsum board installers can quickly learn most application techniques in a few hours.

Durability

Knauf Gypsum board is used to construct strong, high quality walls and ceilings that offer excellent dimensional stability and durability. Surfaces created using gypsum board are easily decorated and refinished.

Economy

Knauf Gypsum board is readily available and easy to apply. It is an inexpensive wall surfacing material that provides a fire resistant interior finish. Gypsum board building systems can generally be installed at significantly lower labor costs than most alternate systems.

Versatility

Knauf Gypsum board satisfies a wide range of architectural requirements for design. Ease of application, performance, ease of repair, availability, and its adaptability to all forms of decoration combine to make gypsum board unmatched by any other surfacing product.



SYSTEM / PRODUCT TESTING AND PERFORMANCE

TYPE X GYPSUM BOARD

ASTM C 1396 describes two types of gypsum board- regular and type X - each providing a different degree of fire resistance.

Type X (special fire-resistant) gypsum board, when tested in accordance with Test Methods E 119, shall provide the following minimum fire resistance for the assemblies described: One hour for a 5/8-in. [15.9-mm] thickness applied to a partition in a single-layer application on each side of 3 5/8-in. [92-mm] deep non-loadbearing galvanized steel studs complying with Specification C645, spaced 24 in. [610 mm] on center. The 5/8-in. [15.9-mm] thick gypsum board 48 in. [1220mm] wide shall be attached using 1-in. [25-mm] long drywall screws spaced 8 in. [203 mm] on center along the edges and ends, and 12 in. [304 mm] along intermediate studs. All joints shall be oriented parallel to and located over studs and staggered on opposite sides of the assembly.

Two hours for a 1/2-in. [12.7-mm] thickness applied to a partition in a double-layer application on each side of 2 1/2-in. [64-mm] deep non-loadbearing galvanized steel studs complying with Specification C 645, spaced 24 in. [610 mm] on center. The 48-in. [1220-mm] wide base layer shall be attached using 1-in. [25-mm] long drywall screws spaced 12 in. [304 mm] on center along board edges, ends, and along intermediate studs. Joints shall be oriented parallel to and located over studs and staggered on opposite sides of the assembly.

The 48-in. [1220-m] wide face layer shall be attached using 1 5/8-in. [41-mm] long drywall screws spaced 12 in. [304 mm] along board edges, ends, and along intermediate studs. Joints shall be oriented parallel to and located over studs, offset 24 in. [610 mm] from the base layer joints, and staggered on opposite sides of the assembly.

Type X Gypsum boards manufactured by Knauf LLC are identified as GW-TX, GB-WRTX, coreboard, GB-WR Mold, These boards are all certified and listed by Intertek. See via website at <https://whdirectory.intertek.com>

FIRE RESISTANCE TESTS

All fire-resistance classifications described in this Manual are derived from full-scale fire tests conducted in accordance with the requirements of ASTM E 119 (as amended and in effect on the date of the test) by recognized independent laboratories. Fire-resistance classifications are the results of tests conducted on systems made up of specific materials put together in a specified manner. There are a number of nationally recognized laboratories capable of conducting tests to establish fire resistance classifications according to the procedures outlined in ASTM E 119. The conditions under which tests are conducted are thoroughly detailed and the fire-resistance classification is established as the time at which there is excessive temperature rise, passage of flame, or structural collapse. In addition, failure may result because of penetration by the pressurized hose stream required in the fire test procedure for walls. With reference to all tested systems, ASTM E 119 states: It is the intent that classifications shall register performance during the period of exposure and shall not be construed as having determined suitability for use after fire exposure. Comprehensive research by fire protection experts has determined the average combustible content normally present within any given occupancy. In addition, evacuation times, the time required for the contents to be consumed by fire, and the resulting temperature rise have been quantified. Fire-resistance requirements are established accordingly in building codes and similar regulations. In ASTM E 119 fire tests, wall, ceiling, column, and beam systems are exposed in a furnace which reaches the indicated average temperatures at the time stated in the standard time-temperature curve (Figure 1) and Appendix X1 of ASTM E119. The unexposed surface of all systems refers to the surface away from the fire during a test. The exposed surface refers to the surface facing the fire.

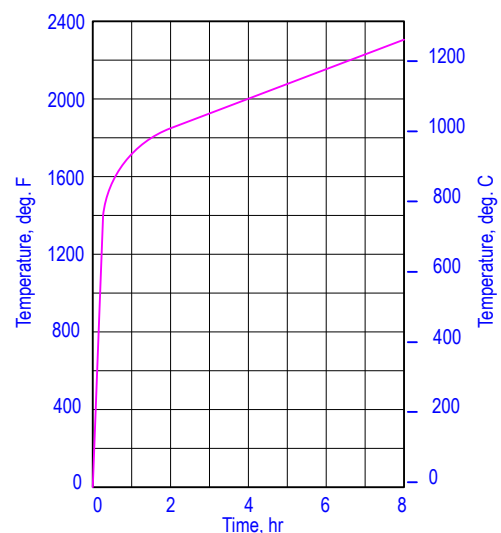

Figure 1

SURFACE BURNING CHARACTERISTICS

Flame spread ratings are intended as a guide in the selection and use of finishing materials and are obtained by measuring the extent and rapidity in which flames spread over their surface under test conditions.

Under certain circumstances it is required that the use of interior finishing materials have a flame spread rating of not more than 25. The common terminology generally used by laboratories for flame spread testing is referred to as tunnel testing.

ASTM E84 - Standard Test Method for Surface Burning Characteristics of Building Materials

The purpose of this test method is to determine the relative burning behavior of the material by observing the flame spread along the specimen. Flame spread and smoke developed indices are then reported.

Table -1 List of the typical surface burning characteristics for gypsum products as well as the standard materials referenced in the test method.

TABLE - 1 SURFACE BURNING CHARACTERISTICS		
	FLAME SPREAD	SMOKE DEVELOPED
Inorganic Reinforced Cement Board	0	0
Gypsum Plaster	0	0
Glass Mat Gypsum Substrate for use as Sheathing	0	0
Fiber Reinforced Gypsum Panels	5	0
Gypsum Lath	10	0
Exterior Gypsum Soffit Board	15	0
Gypsum Wallboard	15	0
Gypsum Sheathing	15	0
Water-Resistant Gypsum Backing Board	15	0
Red Oak	100	100

SOUND INSULATION

The first essential for airborne sound insulation using any system is to close off air leaks and/or flanking paths by which noise can go through or around the system. Small cracks or holes will increase the sound transmission at the higher frequencies. This can have a detrimental effect on the overall acoustical performance and the STC, particularly for higher rated systems. Failure to observe special construction and design precautions can reduce the effectiveness of the best planned sound control methods. Systems shall be airtight. Recessed wall fixtures, such as medicine cabinets or electrical, telephone, television, and intercom outlets, that penetrate the gypsum board shall not be located back-to-back or in the same stud cavity. Any opening for fixtures or pipes shall be cut to the proper size and sealed. The entire perimeter of a sound insulating system shall be made airtight to prevent sound flanking. Flexible sealant or an acoustical gasket shall be used to seal between the STC rated system and all dissimilar surfaces and also between the system and similar surfaces where perimeter relief is required.

SOUND TRANSMISSION LOSS TESTS

ASTM E 90, Standard Test Method for Laboratory Measurement of Airborne Sound Transmission Loss of Building Partitions, is the procedure for measuring the sound transmission loss (STL) in a laboratory. The STL is the difference between the sound energy (sound pressure level) in a source room and a receiving room when the two rooms are separated by the system being tested.

ASTM E 336, Standard Test Method for Measurement of Airborne Sound Insulation in Buildings, is the procedure to determine the field sound transmission loss (FSTL) between two rooms under field conditions. A system's overall effectiveness in resisting the transmission of airborne sound, whether it is a wall, partition, or floor-ceiling, is reported as a single number derived from an analysis of the STL or FSTL curve. This rating is the Sound transmission Class (STC) or Field Sound Transmission Class (FSTC).

* Acoustic values given for the systems within this manual are based on Marshall Day prediction.

KNAUF PARTITIONS

These pages highlight which Knauf Drywall systems are most suited to meet performance criteria and bring a variety of construction and end user benefits to the sector you are designing for.



Schools, Universities,
Training Facilities, Colleges

Cinemas, Theatres,
Auditoriums





Hospitals, Clinics,
Offices



PARTITIONS

Knauf offers a wide range of non-load bearing lightweight partition systems. These partition systems can be implemented in the design of many types of buildings including residential housing, flats and apartments, commercial and industrial properties. These lightweight partition systems are designed to offer high performance to meet the most demanding fire resistance, sound insulation and height requirements.

Offering quick and simple speed of installation constructed from high quality Knauf components, our partitions are guaranteed to perform. KNAUF PARTITIONS provide satisfaction and reassurance in knowing that these components have been comprehensively tested together to ensure their performance, and that our support extends from concept to site.

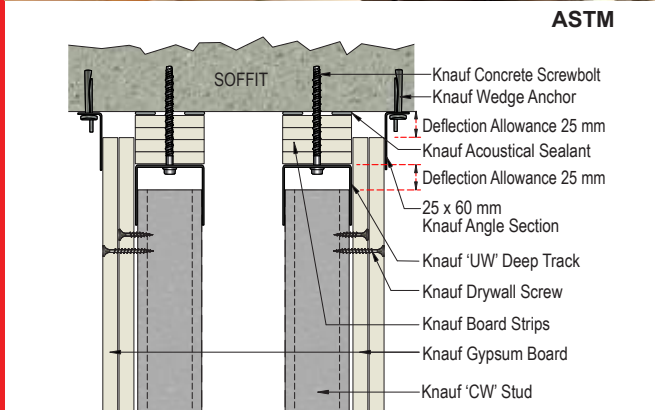
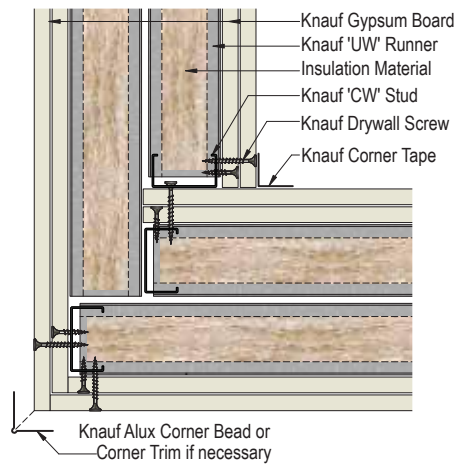
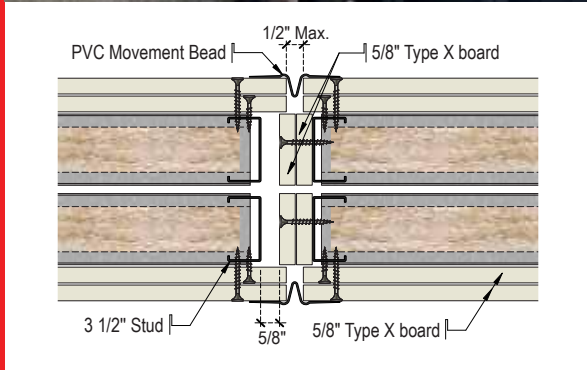
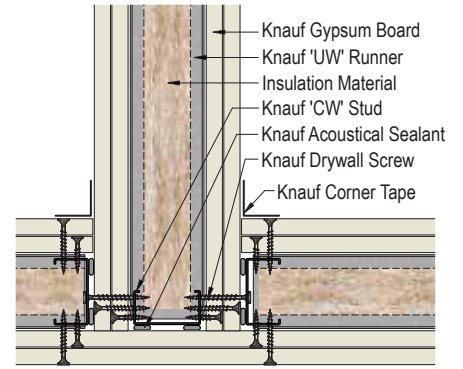

SYSTEMS OVERVIEW

SYSTEMS DESIGNED TO MEET BUILDING REQUIREMENTS







Knauf offers systems for a large variety of building requirements, all fully complying to ASTM standards.

- Fire protection
 - Moisture Resistance
- Sound insulation
 - Heavy duty walls
- High partitions
 - Aesthetics

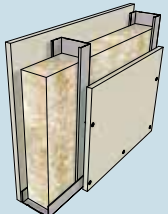
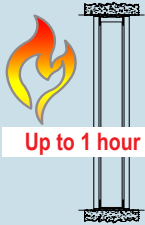
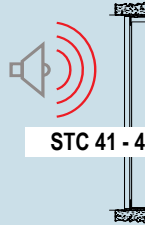
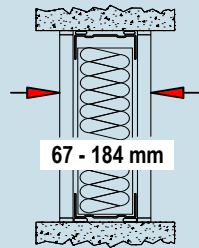
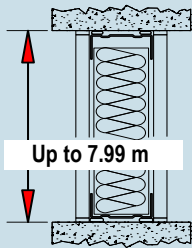
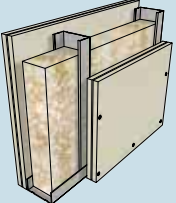
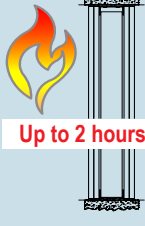
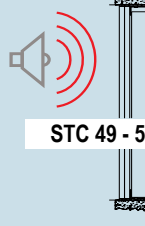
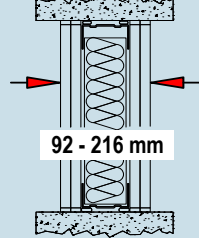
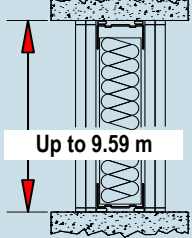
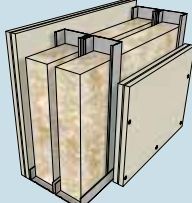
These systems are composed of gypsum boards and metal framing, joint compounds and other materials such as joint tapes, sealants, screws and insulation.

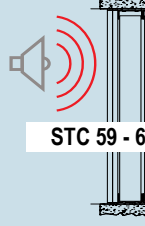
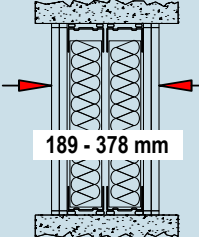
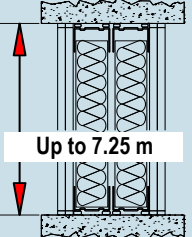
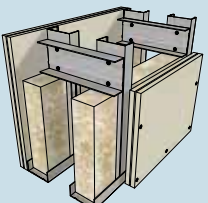
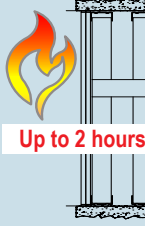
The products alone do not provide performance, the performance is given by the complete assembled system. System performance is achieved on following the correct installation details such as stud spacing and fixing centers, as well as using the nominated components such as gypsum boards, compounds, studs and insulation. The smallest of details such as the sealing of penetrations can have a large effect on the overall system performance.

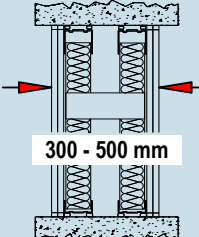
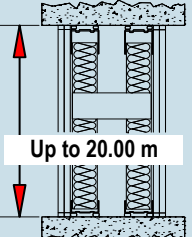
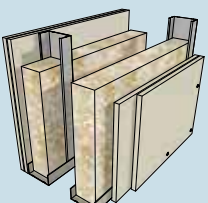
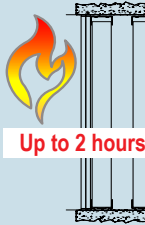
Variations in construction or materials may reduce a system's fire and acoustic rating, structural capacity or other aspects of performance.

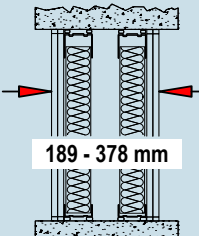
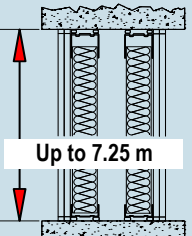
Systems	Performance	Fire resistance	Sound Reduction (STC)	Partition Width	Maximum Height
KW A111 	<ul style="list-style-type: none"> ■ Economical solution ■ Fast space division 	 Up to 1 hour	 STC 41 - 47	 67 - 184 mm	 Up to 7.99 m
KW A112 	<ul style="list-style-type: none"> ■ Optimum solution ■ Meets most design criteria ■ Small footprint ■ High fire resistance 	 Up to 2 hours	 STC 49 - 54	 92 - 216 mm	 Up to 9.59 m
KW A115 	<ul style="list-style-type: none"> ■ High acoustic performances ■ High fire resistance ■ Optimum for separation walls 	 Up to 2 hours	 STC 59 - 62	 189 - 378 mm	 Up to 7.25 m
KW A116 	<ul style="list-style-type: none"> ■ Accommodates large service runs ■ High fire resistance ■ Adjustable footprint ■ High walls solution 	 Up to 2 hours	 STC 56	 300 - 500 mm	 Up to 20.00 m
KW A/S115 	<ul style="list-style-type: none"> ■ High acoustic performances ■ High fire resistance ■ Optimum for separation walls 	 Up to 2 hours	 STC 61 - 65	 189 - 378 mm	 Up to 7.25 m

KW A111

CONNECTIONS AND JOINTS

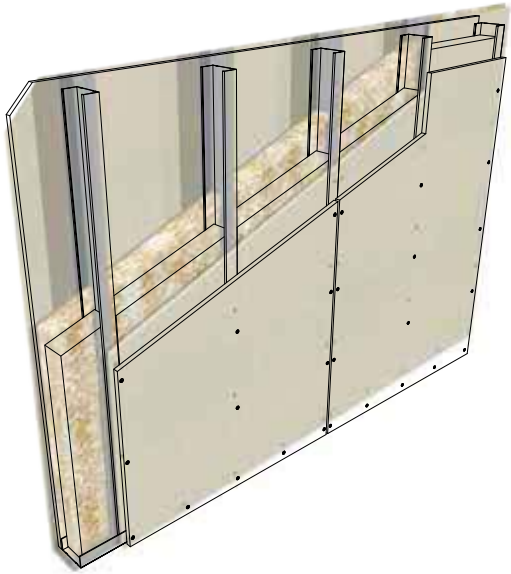

Structural Heights for 24"(609 mm) / 16"(406 mm) / 12"(304 mm) stud spacing

Maximum structural heights are calculated for a static wind load of 240 Pa (5 psf) at deflection criteria L/240.

Structural calculations available for L/360, please contact Technical Department for details.

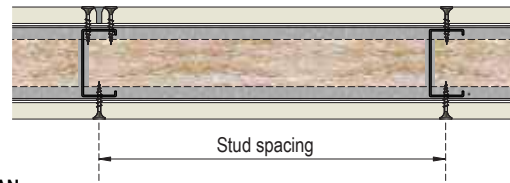

PLAN

KW A111 Wall Connection

PLAN

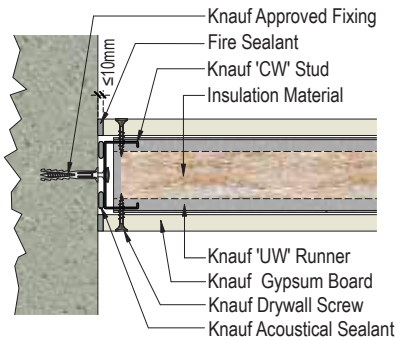

KW A111 T Junction

PLAN

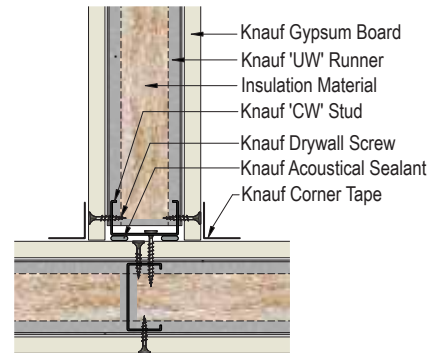

KW A111 Joint

ELEVATION

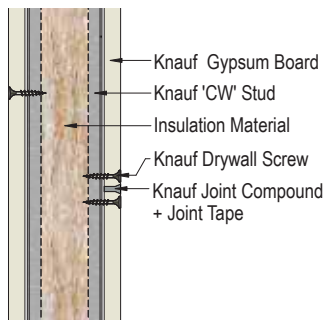

KW A111 T Junction - alternative

PLAN

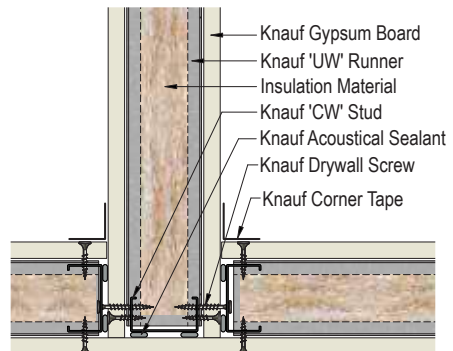

KW A111 Knauf floor connection

ELEVATION

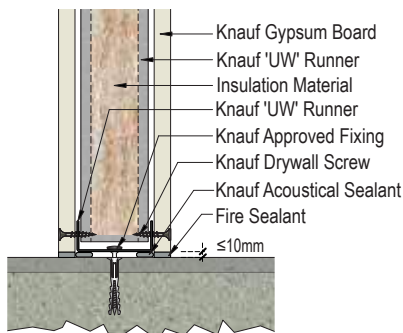

KW A111 Corner detail

PLAN

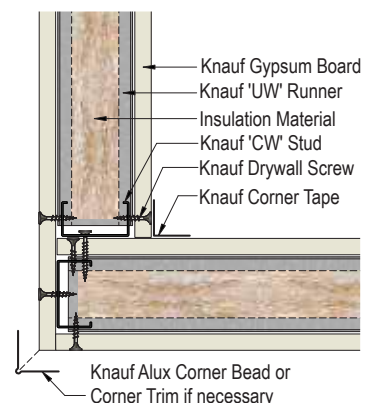

KW A111

SPACING & HEIGHT

Stud size	Stud Spacing (center to center)	Max. Structural Height	
		25 GA (0.5 mm thick)	20 GA (0.9 mm thick)
CW 1 5/8" / (CW 41 mm)	24" (609 mm)	3.13 m	3.34 m
	16" (406 mm)	3.46 m	3.72 m
	12" (304 mm)	3.64 m	3.95 m
CW 2 1/2" / (CW 64 mm)	24" (609 mm)	3.77 m	4.19 m
	16" (406 mm)	4.36 m	4.83 m
	12" (304 mm)	4.72 m	5.26 m
CW 1 5/8" / (CW 89 mm)	24" (609 mm)	4.43 m	5.10 m
	16" (406 mm)	5.26 m	5.96 m
	12" (304 mm)	5.74 m	6.54 m
CW 2 1/2" / (CW 102 mm)	24" (609 mm)	5.62 m	6.21 m
	16" (406 mm)	6.29 m	6.95 m
	12" (304 mm)	6.74 m	7.48 m
CW 2 1/2" / (CW 152 mm)	24" (609 mm)	7.03m	7.99 m
	16" (406 mm)	8.05 m	9.12 m
	12" (304 mm)	8.72 m	9.88 m

KW A111 Ceiling connection, up to 10 mm deflection

ELEVATION

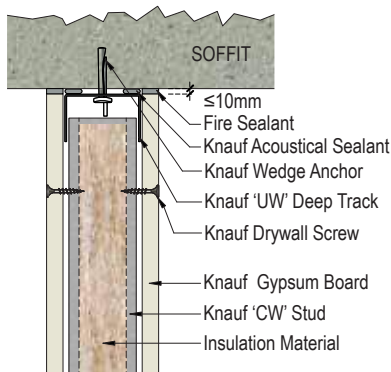

- Knauf Drywall systems can provide deflection up to 10 mm using the standard detail and standard flange UW track (1 inch / 25 mm)

KW A111 Ceiling connection, up to ± 25 mm deflection

ELEVATION

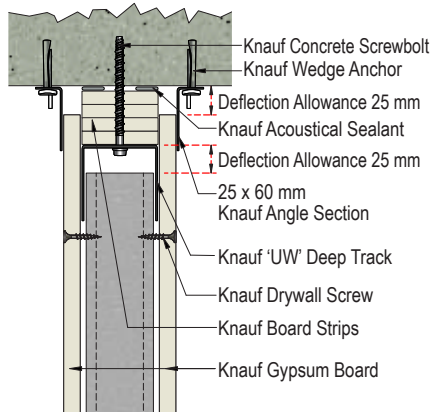

- Higher deflection requirement can be achieved using the tested head of wall (minimum stud size 2 1/2 inch – 64 mm)
- Fire Rating up to 1 hour (using GW-TX Type X boards 15.9mm)
- Deep Flange UW track 2-3/8 inch (60 mm)
- Steel angle : 25 GA (0.5 mm) galvanized steel with one leg measuring 1 in. (25 mm) and the other angle 3/8 in. (10 mm) longer than the maximum Head of Wall Joint opening.

Design Number KL/GBF 120-01

Head of Wall Joint / Knauf Fire Resistant Gypsum Board

ASTM E1966 / Fire Resistance Rating: 1 hr

Maximum Joint Opening – 2 in. (50mm)

Minimum Joint Opening – 1 in. (25mm)

KW A111

SYSTEMS BUILD-UP

Profile Thickness:
0.5 mm (25 Gauge)

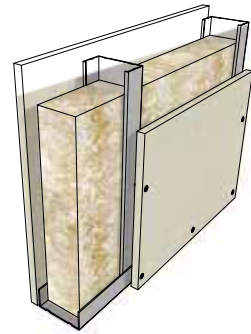

Board Type	Cladding thickness	Studs size	Total thickness	Max. Height	Approx. Weight	Sound Insulation (ASTM E90) STC	Min. Insulation thickness (min. 16 kg/m3)	Fire rating (ASTM E119)
------------	--------------------	------------	-----------------	-------------	----------------	---------------------------------	---	-------------------------

Studs ASTM C645-00 Nonstructural Steel Framing Members, 25 Gauge (0.5 mm thick), flange 1.3 in (33 mm), spacing 24 in. (610 mm)

GW-R	1 x 1/2" (1 x 12.7 mm)	CW 1 5/8" (CW 41 mm)	2 5/8" (66.4 mm)	3.13 m	27 kg / m2	41 STC		-
Type X	1 x 1/2" (1 x 12.7 mm)	CW 1 5/8" (CW 41 mm)	2 5/8" (66.4 mm)	3.13 m	27 kg / m2	42 STC	25 mm	-
GW-R	1 x 5/8" (1 x 15.9 mm)	CW 1 5/8" (CW 41 mm)	2 7/8" (72.8 mm)	3.13 m	30 kg / m2	42 STC		-
Type X	1 x 5/8" (1 x 15.9 mm)	CW 1 5/8" (CW 41 mm)	2 7/8" (72.8 mm)	3.13 m	32 kg / m2	43 STC		1 hour ⁽¹⁾

GW-R	1 x 1/2" (1 x 12.7 mm)	CW 2 1/2" (CW 64 mm)	3 1/2" (89 mm)	3.77 m	25 kg / m2	42 STC		-
Type X	1 x 1/2" (1 x 12.7 mm)	CW 2 1/2" (CW 64 mm)	3 1/2" (89 mm)	3.77 m	27 kg / m2	43 STC	50 mm	-
GW-R	1 x 5/8" (1 x 15.9 mm)	CW 2 1/2" (CW 64 mm)	3 3/4" (96 mm)	3.77 m	30 kg / m2	43 STC		-
Type X	1 x 5/8" (1 x 15.9 mm)	CW 2 1/2" (CW 64 mm)	3 3/4" (96 mm)	3.77 m	32 kg / m2	44 STC		1 hour

GW-R	1 x 1/2" (1 x 12.7 mm)	CW 3 1/2" (CW 89 mm)	4 1/2" (114 mm)	4.43 m	25 kg / m2	43 STC		-
Type X	1 x 1/2" (1 x 12.7 mm)	CW 3 1/2" (CW 89 mm)	4 1/2" (114 mm)	4.43 m	27 kg / m2	45 STC	75 mm	-
GW-R	1 x 5/8" (1 x 15.9 mm)	CW 3 1/2" (CW 89 mm)	4 3/4" (121 mm)	4.43 m	30 kg / m2	44 STC		-
Type X	1 x 5/8" (1 x 15.9 mm)	CW 3 1/2" (CW 89 mm)	4 3/4" (121 mm)	4.43 m	32 kg / m2	46 STC		1 hour

GW-R	1 x 1/2" (1 x 12.7 mm)	CW 4 1/32" (CW 102 mm)	5" (127 mm)	5.62 m	25 kg / m2	44 STC		-
Type X	1 x 1/2" (1 x 12.7 mm)	CW 4 1/32" (CW 102 mm)	5" (127 mm)	5.62 m	27 kg / m2	46 STC	100 mm	-
GW-R	1 x 5/8" (1 x 15.9 mm)	CW 4 1/32" (CW 102 mm)	5 1/4" (134 mm)	5.62 m	30 kg / m2	45 STC		-
Type X	1 x 5/8" (1 x 15.9 mm)	CW 4 1/32" (CW 102 mm)	5 1/4" (134 mm)	5.62 m	32 kg / m2	47 STC		1 hour

GW-R	1 x 1/2" (1 x 12.7 mm)	CW 5 63/64" (CW 152 mm)	7" (177 mm)	7.03 m	25 kg / m2	44 STC		-
Type X	1 x 1/2" (1 x 12.7 mm)	CW 5 63/64" (CW 152 mm)	7" (177 mm)	7.03 m	27 kg / m2	46 STC	150 mm	-
GW-R	1 x 5/8" (1 x 15.9 mm)	CW 5 63/64" (CW 152 mm)	7 1/4" (184 mm)	7.03 m	30 kg / m2	45 STC		-
Type X	1 x 5/8" (1 x 15.9 mm)	CW 5 63/64" (CW 152 mm)	7 1/4" (184 mm)	7.03 m	32 kg / m2	47 STC		1 hour

(1) As per Gypsum Association – Fire Resistance Design Manual GA-600-2012, GA file no. WP 1340.

For solutions requiring 240 Pa load and/or L/360 deflection criteria, please contact Knauf Technical Department. For wet areas, use of Knauf Water Resistant Board (GB-WR and GB-WRTX) is recommended. For tiles application reduce the stud spacing to 406 mm, or use double layer solution.

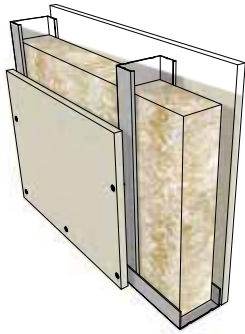

KW A111

SYSTEMS BUILD-UP

Profile Thickness:
0.9 mm (20 Gauge)

Board Type	Cladding thickness	Studs size	Total thickness	Max. Height	Approx. Weight	Sound Insulation (ASTM E90) STC	Min. Insulation thickness (min. 16 kg/m ³)	Fire rating (ASTM E119)
------------	--------------------	------------	-----------------	-------------	----------------	---------------------------------	--	-------------------------

Studs ASTM C645-00 Nonstructural Steel Framing Members, 20 Gauge (0.9 mm thick), flange 1.3 in. (33 mm), spacing 24 in. (610 mm)

GW-R	1 x 1/2" (1 x 12.7 mm)	CW 1 5/8" (CW 41 mm)	2 5/8" (66.4 mm)	3.34 m	27 kg / m ²	41 STC		-
Type X	1 x 1/2" (1 x 12.7 mm)	CW 1 5/8" (CW 41 mm)	2 5/8" (66.4 mm)	3.34 m	27 kg / m ²	42 STC	25 mm	-
GW-R	1 x 5/8" (1 x 15.9 mm)	CW 1 5/8" (CW 41 mm)	2 7/8" (72.8 mm)	3.34 m	30 kg / m ²	42 STC		-
Type X	1 x 5/8" (1 x 15.9 mm)	CW 1 5/8" (CW 41 mm)	2 7/8" (72.8 mm)	3.34 m	32 kg / m ²	43 STC		1 hour ⁽¹⁾

GW-R	1 x 1/2" (1 x 12.7 mm)	CW 2 1/2" (CW 64 mm)	3 1/2" (89 mm)	4.19 m	25 kg / m ²	42 STC		-
Type X	1 x 1/2" (1 x 12.7 mm)	CW 2 1/2" (CW 64 mm)	3 1/2" (89 mm)	4.19 m	27 kg / m ²	43 STC	50 mm	-
GW-R	1 x 5/8" (1 x 15.9 mm)	CW 2 1/2" (CW 64 mm)	3 3/4" (96 mm)	4.19 m	30 kg / m ²	43 STC		-
Type X	1 x 5/8" (1 x 15.9 mm)	CW 2 1/2" (CW 64 mm)	3 3/4" (96 mm)	4.19 m	32 kg / m ²	44 STC		1 hour

GW-R	1 x 1/2" (1 x 12.7 mm)	CW 3 1/2" (CW 89 mm)	4 1/2" (114 mm)	5.10 m	25 kg / m ²	43 STC		-
Type X	1 x 1/2" (1 x 12.7 mm)	CW 3 1/2" (CW 89 mm)	4 1/2" (114 mm)	5.10 m	27 kg / m ²	45 STC	75 mm	-
GW-R	1 x 5/8" (1 x 15.9 mm)	CW 3 1/2" (CW 89 mm)	4 3/4" (121 mm)	5.10 m	30 kg / m ²	44 STC		-
Type X	1 x 5/8" (1 x 15.9 mm)	CW 3 1/2" (CW 89 mm)	4 3/4" (121 mm)	5.10 m	32 kg / m ²	46 STC		1 hour

GW-R	1 x 1/2" (1 x 12.7 mm)	CW 4 1/32" (CW 102 mm)	5" (127 mm)	6.21 m	25 kg / m ²	44 STC		-
Type X	1 x 1/2" (1 x 12.7 mm)	CW 4 1/32" (CW 102 mm)	5" (127 mm)	6.21 m	27 kg / m ²	46 STC	100 mm	-
GW-R	1 x 5/8" (1 x 15.9 mm)	CW 4 1/32" (CW 102 mm)	5 1/4" (134 mm)	6.21 m	30 kg / m ²	45 STC		-
Type X	1 x 5/8" (1 x 15.9 mm)	CW 4 1/32" (CW 102 mm)	5 1/4" (134 mm)	6.21 m	32 kg / m ²	47 STC		1 hour

GW-R	1 x 1/2" (1 x 12.7 mm)	CW 5 63/64" (CW 152 mm)	7" (177 mm)	7.99 m	25 kg / m ²	44 STC		-
Type X	1 x 1/2" (1 x 12.7 mm)	CW 5 63/64" (CW 152 mm)	7" (177 mm)	7.99 m	27 kg / m ²	46 STC	150 mm	-
GW-R	1 x 5/8" (1 x 15.9 mm)	CW 5 63/64" (CW 152 mm)	7 1/4" (184 mm)	7.99 m	30 kg / m ²	45 STC		-
Type X	1 x 5/8" (1 x 15.9 mm)	CW 5 63/64" (CW 152 mm)	7 1/4" (184 mm)	7.99 m	32 kg / m ²	47 STC		1 hour

(1) As per Gypsum Association – Fire Resistance Design Manual GA-600-2012, GA file no. WP 1340.

For solutions requiring 240 Pa load and/or L/360 deflection criteria, please contact Knauf Technical Department. For wet areas, use of Knauf Water Resistant Board (GB-WR and GB-WRTX) is recommended. For tiles application reduce the stud spacing to 406 mm, or use double layer solution.

KW A112

CONNECTIONS AND JOINTS

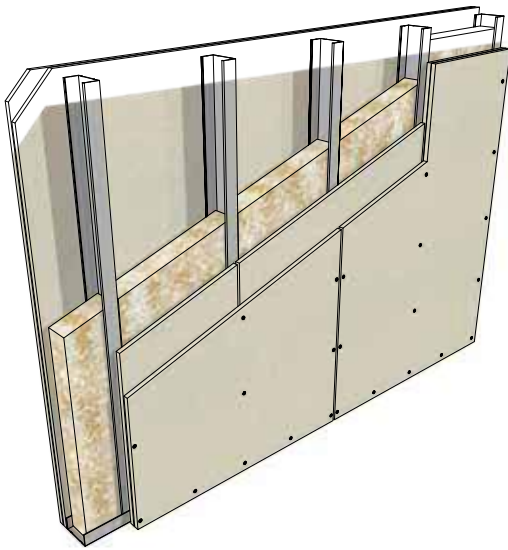

Structural Heights for 24"(609 mm) / 16"(406 mm) / 12"(304 mm) stud spacing

Maximum structural heights are calculated for a static wind load of 240 Pa (5 psf) at deflection criteria L/240.

Structural calculations available for L/360, please contact Technical Department for details.

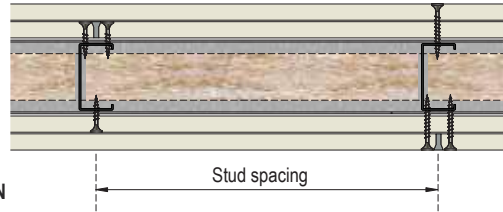

KW A112 Wall Connection

PLAN

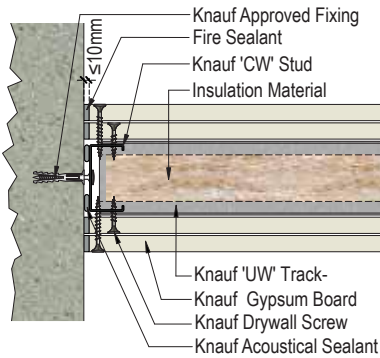

KW A112 T Junction

PLAN

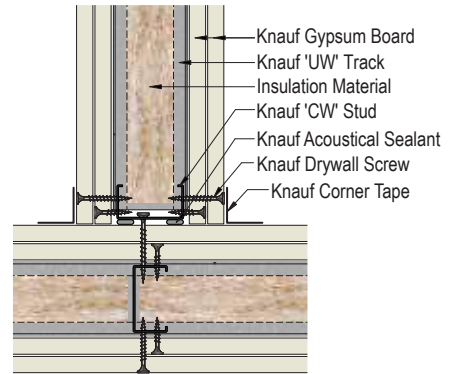

KW A112 Joint

ELEVATION

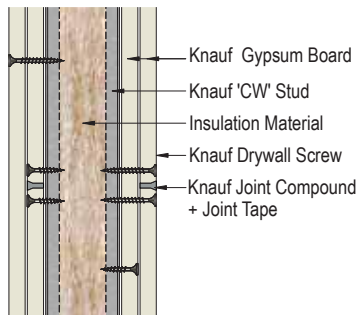

KW A112 T Junction - alternative

PLAN

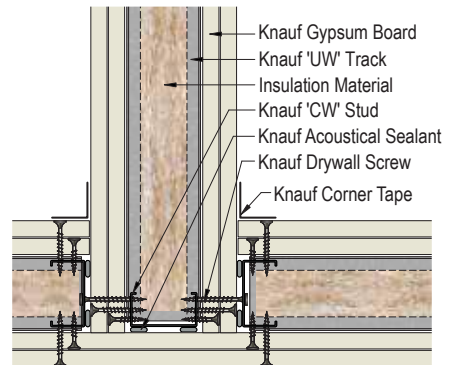

KW A112 Knauf floor connection

ELEVATION

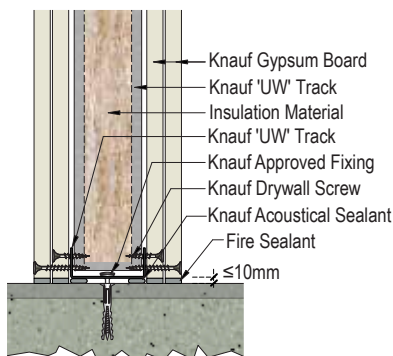

KW A112 Corner detail

PLAN

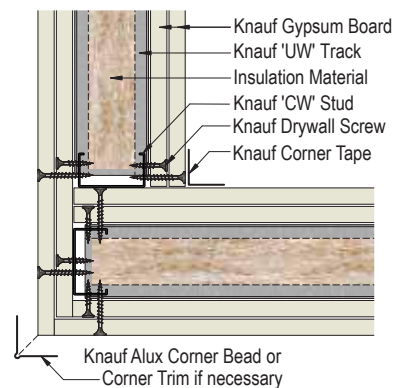

KW A112

SPACING & HEIGHT

Stud size	Stud Spacing (center to center)	Max. Structural Height	
		25 GA (0.5 mm thick)	20 GA (0.9 mm thick)
CW 1 5/8" / (CW 41 mm)	24" (609 mm)	4.39 m	4.51 m
	16" (406 mm)	4.55 m	4.71 m
	12" (304 mm)	4.67 m	4.85 m
CW 2 1/2" / (CW 64 mm)	24" (609 mm)	5.60 m	5.82 m
	16" (406 mm)	5.89 m	6.17 m
	12" (304 mm)	6.09 m	6.41 m
CW 1 5/8" / (CW 89 mm)	24" (609 mm)	6.52 m	6.88 m
	16" (406 mm)	7.06 m	7.48 m
	12" (304 mm)	7.39 m	7.86 m
CW 2 1/2" / (CW 102 mm)	24" (609 mm)	7.11 m	7.51 m
	16" (406 mm)	7.71 m	8.17 m
	12" (304 mm)	8.07 m	8.62 m
CW 2 1/2" / (CW 152 mm)	24" (609 mm)	8.92 m	9.59 m
	16" (406 mm)	9.86 m	10.64 m
	12" (304 mm)	10.44 m	11.30 m

KW A112 Ceiling connection, up to 10 mm deflection

ELEVATION

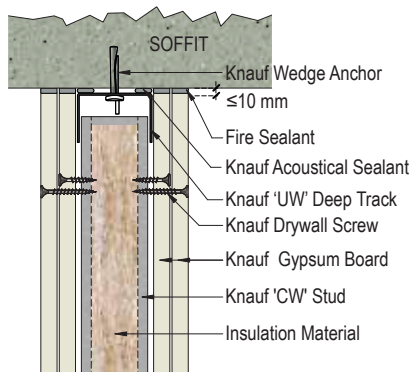

- Knauf Drywall systems can provide deflection up to 10 mm using the standard detail and standard flange UW track (1 inch / 25 mm)

KW A112 Ceiling connection, up to ± 25 mm deflection

ELEVATION

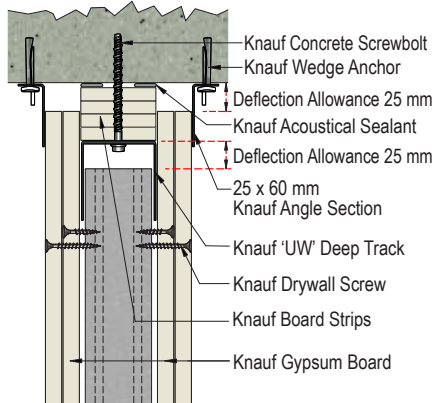

- Higher deflection requirement can be achieved using the tested head of wall (minimum stud size 2 1/2 inch – 64 mm)
- Fire Rating up to 2 hours (using GW-TX Type X boards 15.9mm)
- Deep Flange UW track 2-3/8 inch (60 mm)
- Steel angle : 25 GA (0.5 mm) galvanized steel with one leg measuring 1 in. (25 mm) and the other angle 3/8 in. (10 mm) longer than the maximum Head of Wall Joint opening.

Design Number KL/GBF 120-01

Head of Wall Joint / Knauf Fire Resistant Gypsum Board

ASTM E1966 / Fire Resistance Rating: 2 hrs

Maximum Joint Opening – 2 in. (50mm)

Minimum Joint Opening – 1 in. (25mm)

KW A112

SYSTEMS BUILD-UP

Profile Thickness:
0.5 mm (25 Gauge)

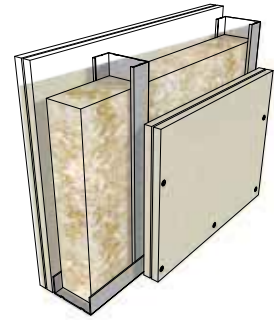

Board Type	Cladding thickness	Studs size	Total thickness	Max. Height	Approx. Weight	Sound Insulation (ASTM E90) STC	Min. Insulation thickness (min. 16 kg/m3)	Fire rating (ASTM E119)
------------	--------------------	------------	-----------------	-------------	----------------	---------------------------------	---	-------------------------

Studs ASTM C645-00 Nonstructural Steel Framing Members, 25 Gauge (0.5 mm thick), flange 1.3 in (33 mm), spacing 24 in. (610 mm)

GW-R	2 x 1/2" (2 x 12.7 mm)	CW 1 5/8" (CW 41 mm)	3 5/8" (91.8 mm)	4.39 m	45 kg / m2	49 STC		-
Type X	2 x 1/2" (2 x 12.7 mm)	CW 1 5/8" (CW 41 mm)	3 5/8" (91.8 mm)	4.39 m	48 kg / m2	50 STC	25 mm	-
GW-R	2 x 5/8" (2 x 15.9 mm)	CW 1 5/8" (CW 41 mm)	4 1/8" (104.6 mm)	4.39 m	56 kg / m2	51 STC		-
Type X	2 x 5/8" (2 x 15.9 mm)	CW 1 5/8" (CW 41 mm)	4 1/8" (104.6 mm)	4.39 m	59 kg / m2	52 STC		2 hours ⁽¹⁾

GW-R	2 x 1/2" (2 x 12.7 mm)	CW 2 1/2" (CW 64 mm)	4 1/2" (115 mm)	5.60 m	45 kg / m2	49 STC		-
Type X	2 x 1/2" (2 x 12.7 mm)	CW 2 1/2" (CW 64 mm)	4 1/2" (115 mm)	5.60 m	48 kg / m2	50 STC	50 mm	2 hours
GW-R	2 x 5/8" (2 x 15.9 mm)	CW 2 1/2" (CW 64 mm)	5 1/6" (128 mm)	5.60 m	56 kg / m2	51 STC		-
Type X	2 x 5/8" (2 x 15.9 mm)	CW 2 1/2" (CW 64 mm)	5 1/6" (128 mm)	5.60 m	59 kg / m2	52 STC		2 hours

GW-R	2 x 1/2" (2 x 12.7 mm)	CW 3 1/2" (CW 89 mm)	5 1/2" (140 mm)	6.52 m	45 kg / m2	50 STC		-
Type X	2 x 1/2" (2 x 12.7 mm)	CW 3 1/2" (CW 89 mm)	5 1/2" (140 mm)	6.52 m	48 kg / m2	51 STC	75 mm	2 hours
GW-R	2 x 5/8" (2 x 15.9 mm)	CW 3 1/2" (CW 89 mm)	6" (153 mm)	6.52 m	56 kg / m2	52 STC		-
Type X	2 x 5/8" (2 x 15.9 mm)	CW 3 1/2" (CW 89 mm)	6" (153 mm)	6.52 m	59 kg / m2	53 STC		2 hours

GW-R	2 x 1/2" (2 x 12.7 mm)	CW 4 1/32" (CW 102 mm)	6" (153 mm)	7.11 m	45 kg / m2	51 STC		-
Type X	2 x 1/2" (2 x 12.7 mm)	CW 4 1/32" (CW 102 mm)	6" (153 mm)	7.11 m	48 kg / m2	52 STC	100 mm	2 hours
GW-R	2 x 5/8" (2 x 15.9 mm)	CW 4 1/32" (CW 102 mm)	6 9/16" (166 mm)	7.11 m	56 kg / m2	52 STC		-
Type X	2 x 5/8" (2 x 15.9 mm)	CW 4 1/32" (CW 102 mm)	6 9/16" (166 mm)	7.11 m	59 kg / m2	53 STC		2 hours

GW-R	2 x 1/2" (2 x 12.7 mm)	CW 5 63/64" (CW 152 mm)	8" (203 mm)	8.92 m	45 kg / m2	52 STC		-
Type X	2 x 1/2" (2 x 12.7 mm)	CW 5 63/64" (CW 152 mm)	8" (203 mm)	8.92 m	48 kg / m2	53 STC	150 mm	2 hours
GW-R	2 x 5/8" (2 x 15.9 mm)	CW 5 63/64" (CW 152 mm)	8 1/2" (216 mm)	8.92 m	56 kg / m2	53 STC		-
Type X	2 x 5/8" (2 x 15.9 mm)	CW 5 63/64" (CW 152 mm)	8 1/2" (216 mm)	8.92 m	59 kg / m2	54 STC		2 hours

(1) As per Gypsum Association – Fire Resistance Design Manual GA-600-2012, GA file no. WP 1530.

For solutions requiring 240 Pa load and/or L / 360 deflection criteria, please contact Knauf Technical Department. For wet areas, use of Knauf Water Resistant Board (GB-WR and GB-WRTX) is recommended.

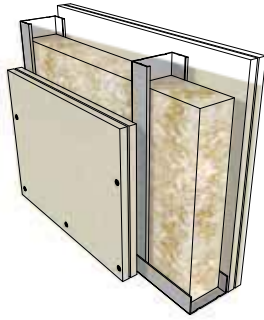

KW A112

SYSTEMS BUILD-UP

Profile Thickness:
0.9 mm (20 Gauge)

Board Type	Cladding thickness	Studs size	Total thickness	Max. Height	Approx. Weight	Sound Insulation (ASTM E90) STC	Min. Insulation thickness (min. 16 kg/m ³)	Fire rating (ASTM E119)
------------	--------------------	------------	-----------------	-------------	----------------	---------------------------------	--	-------------------------

Studs ASTM C645-00 Nonstructural Steel Framing Members, 20 Gauge (0.9 mm thick), flange 1.3 in. (33 mm), spacing 24 in. (610 mm)

GW-R	2 x 1/2" (2 x 12.7 mm)	CW 1 5/8" (CW 41 mm)	3 5/8" (91.8 mm)	4.51 m	45 kg / m ²	49 STC		-
Type X	2 x 1/2" (2 x 12.7 mm)	CW 1 5/8" (CW 41 mm)	3 5/8" (91.8 mm)	4.51 m	48 kg / m ²	50 STC	25 mm	-
GW-R	2 x 5/8" (2 x 15.9 mm)	CW 1 5/8" (CW 41 mm)	4 1/8" (104.6 mm)	4.51 m	56 kg / m ²	51 STC		-
Type X	2 x 5/8" (2 x 15.9 mm)	CW 1 5/8" (CW 41 mm)	4 1/8" (104.6 mm)	4.51 m	59 kg / m ²	52 STC		2 hours ⁽¹⁾

GW-R	2 x 1/2" (2 x 12.7 mm)	CW 2 1/2" (CW 64 mm)	4 1/2" (115 mm)	5.82 m	45 kg / m ²	49 STC		-
Type X	2 x 1/2" (2 x 12.7 mm)	CW 2 1/2" (CW 64 mm)	4 1/2" (115 mm)	5.82 m	48 kg / m ²	50 STC	50 mm	2 hours
GW-R	2 x 5/8" (2 x 15.9 mm)	CW 2 1/2" (CW 64 mm)	5 1/6" (128 mm)	5.82 m	56 kg / m ²	51 STC		-
Type X	2 x 5/8" (2 x 15.9 mm)	CW 2 1/2" (CW 64 mm)	5 1/6" (128 mm)	5.82 m	59 kg / m ²	52 STC		2 hours

GW-R	2 x 1/2" (2 x 12.7 mm)	CW 3 1/2" (CW 89 mm)	5 1/2" (140 mm)	6.88 m	45 kg / m ²	50 STC		-
Type X	2 x 1/2" (2 x 12.7 mm)	CW 3 1/2" (CW 89 mm)	5 1/2" (140 mm)	6.88 m	48 kg / m ²	51 STC	75 mm	2 hours
GW-R	2 x 5/8" (2 x 15.9 mm)	CW 3 1/2" (CW 89 mm)	6" (153 mm)	6.88 m	56 kg / m ²	52 STC		-
Type X	2 x 5/8" (2 x 15.9 mm)	CW 3 1/2" (CW 89 mm)	6" (153 mm)	6.88 m	59 kg / m ²	53 STC		2 hours

GW-R	2 x 1/2" (2 x 12.7 mm)	CW 4 1/32" (CW 102 mm)	6" (153 mm)	7.51 m	45 kg / m ²	51 STC		-
Type X	2 x 1/2" (2 x 12.7 mm)	CW 4 1/32" (CW 102 mm)	6" (153 mm)	7.51 m	48 kg / m ²	52 STC	100 mm	2 hours
GW-R	2 x 5/8" (2 x 15.9 mm)	CW 4 1/32" (CW 102 mm)	6 9/16" (166 mm)	7.51 m	56 kg / m ²	52 STC		-
Type X	2 x 5/8" (2 x 15.9 mm)	CW 4 1/32" (CW 102 mm)	6 9/16" (166 mm)	7.51 m	59 kg / m ²	53 STC		2 hours

GW-R	2 x 1/2" (2 x 12.7 mm)	CW 5 63/64" (CW 152 mm)	8" (203 mm)	9.59 m	45 kg / m ²	52 STC		-
Type X	2 x 1/2" (2 x 12.7 mm)	CW 5 63/64" (CW 152 mm)	8" (203 mm)	9.59 m	48 kg / m ²	53 STC	150 mm	2 hours
GW-R	2 x 5/8" (2 x 15.9 mm)	CW 5 63/64" (CW 152 mm)	8 1/2" (216 mm)	9.59 m	56 kg / m ²	53 STC		-
Type X	2 x 5/8" (2 x 15.9 mm)	CW 5 63/64" (CW 152 mm)	8 1/2" (216 mm)	9.59 m	59 kg / m ²	54 STC		2 hours

(1) As per Gypsum Association – Fire Resistance Design Manual GA-600-2012, GA file no. WP 1530.

For solutions requiring 240 Pa load and/or L/360 deflection criteria, please contact Knauf Technical Department. For wet areas, use of Knauf Water Resistant Board (GB-WR and GB-WRTX) is recommended.

KW A115

CONNECTIONS AND JOINTS

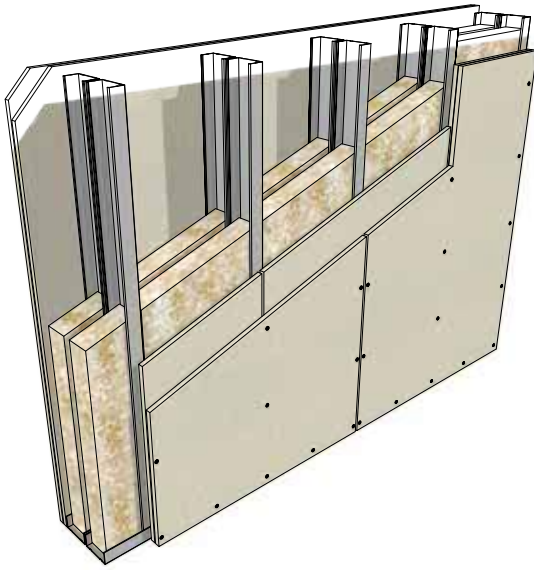

Structural Heights for 24"(609 mm) / 16"(406 mm) / 12"(304 mm) stud spacing

Maximum structural heights are calculated for a static wind load of 240 Pa (5 psf) at deflection criteria L/240.

Structural calculations available for L/360, please contact Technical Department for details.

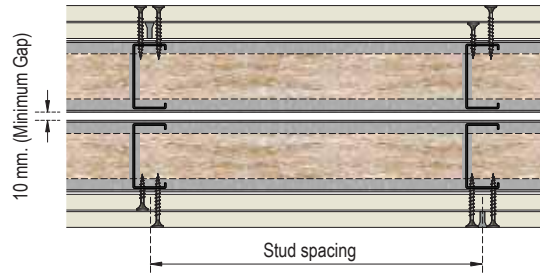

PLAN

KW A115 Wall Connection

PLAN

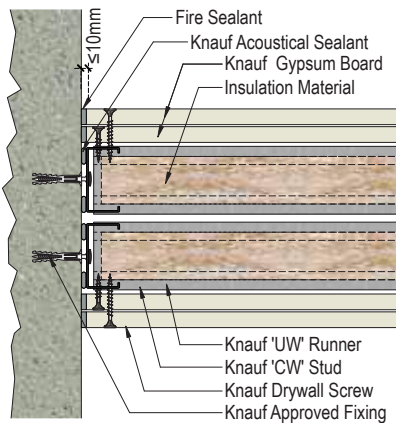

KW A115 Joint

ELEVATION

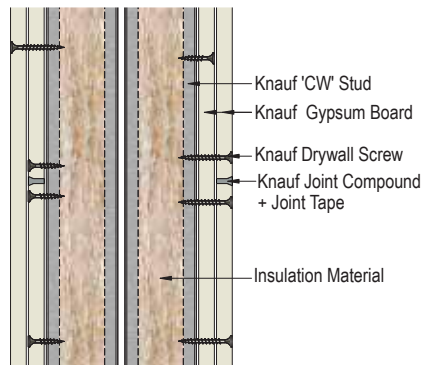

KW A115 Knauf floor connection

ELEVATION

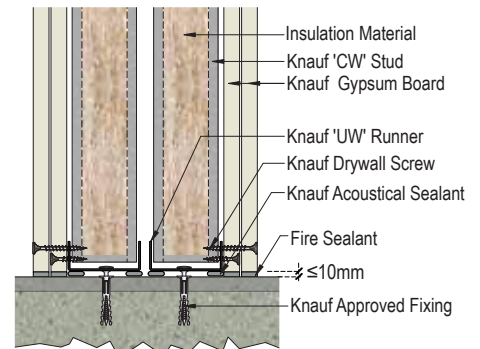

KW A115 T Junction

PLAN

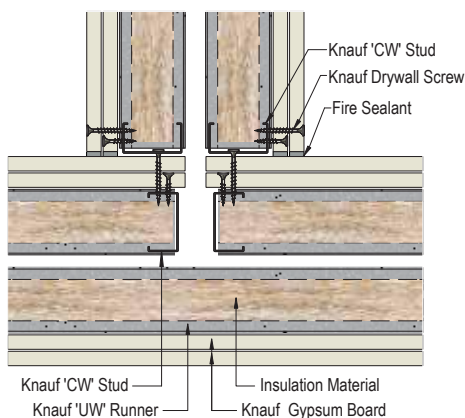

KW A115 Corner detail

PLAN

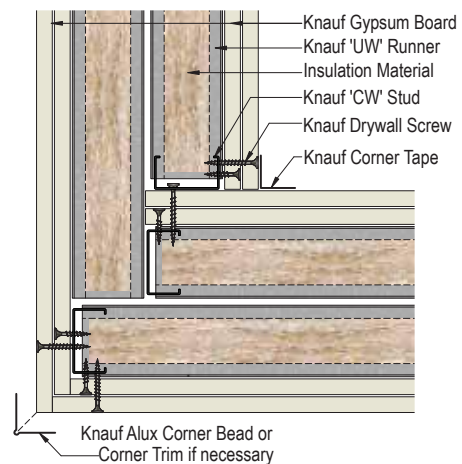

KW A115

SPACING & HEIGHT

Stud size	Stud Spacing (center to center)	Max. Structural Height	
		25 GA (0.5 mm thick)	20 GA (0.9 mm thick)
CW 1 5/8" / (CW 41 mm)	16" (406 mm)	-	-
	12" (304 mm)	-	-
CW 2 1/2" / (CW 64 mm)	24" (609 mm)	3.30 m	3.93 m
	16" (406 mm)	3.78 m	4.50 m
	12" (304 mm)	4.14 m	4.92 m
CW 1 5/8" / (CW 89 mm)	24" (609 mm)	4.09 m	4.91 m
	16" (406 mm)	4.74 m	5.68 m
	12" (304 mm)	5.23 m	6.23 m
CW 2 1/2" / (CW 102 mm)	24" (609 mm)	4.48 m	5.39 m
	16" (406 mm)	5.22 m	6.25 m
	12" (304 mm)	5.74 m	6.86 m
CW 2 1/2" / (CW 152 mm)	24" (609 mm)	5.99 m	7.25 m
	16" (406 mm)	7.04 m	8.44 m
	12" (304 mm)	7.76 m	9.29 m

KW A115 Ceiling connection, up to 10 mm deflection

ELEVATION

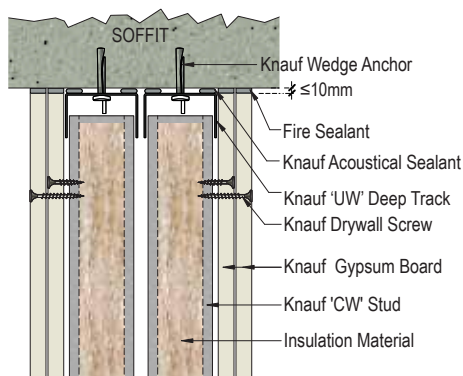

- Knauf Drywall systems can provide deflection up to 10 mm using the standard detail and standard flange UW track (1 inch / 25 mm)

KW A115 Ceiling connection, up to ± 25 mm deflection

ELEVATION

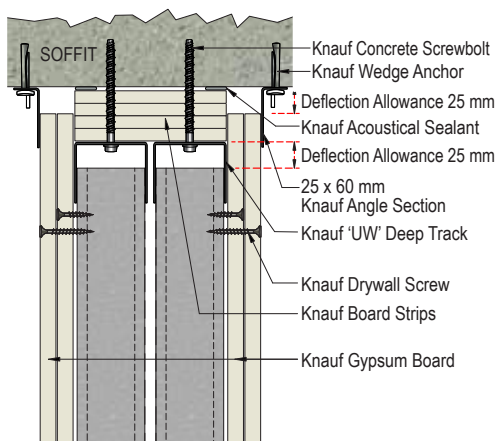

- Higher deflection requirement can be achieved using the tested head of wall (minimum stud size 2 1/2 inch – 64 mm)
- Fire Rating up to 2 hours (using GW-TX Type X boards 15.9mm)
- Deep Flange UW track 2-3/8 inch (60 mm)
- Steel angle : 25 GA (0.5 mm) galvanized steel with one leg measuring 1 in. (25 mm) and the other angle 3/8 in. (10 mm) longer than the maximum Head of Wall Joint opening.

Design Number KL/GBF 120-01

Head of Wall Joint / Knauf Fire Resistant Gypsum Board

ASTM E1966 / Fire Resistance Rating: 2 hrs

Maximum Joint Opening – 2 in. (50mm)

Minimum Joint Opening – 1 in. (25mm)

KW A115

SYSTEMS BUILD-UP

Profile Thickness:
0.5 mm (25 Gauge)



Board Type	Cladding thickness	Studs size	Total thickness	Max. Height	Approx. Weight	Sound Insulation (ASTM E90) STC	Min. Insulation thickness (min. 16 kg/m3)	Fire rating (ASTM E119)
------------	--------------------	------------	-----------------	-------------	----------------	---------------------------------	---	-------------------------

Studs ASTM C645-00 Nonstructural Steel Framing Members, 25 Gauge (0.5 mm thick), flange 1.3 in (33 mm), spacing 24 in. (610 mm)

GW-R	2 x 1/2" (2 x 12.7 mm)	CW 2 1/2" (CW 64 mm)	7 7/16" (189 mm)	3.30 m	45 kg / m2	59 STC		-
Type X	2 x 1/2" (2 x 12.7 mm)	CW 2 1/2" (CW 64 mm)	7 7/16" (189 mm)	3.30 m	49 kg / m2	60 STC	50 mm	2 hour
GW-R	2 x 5/8" (2 x 15.9 mm)	CW 2 1/2" (CW 64 mm)	7 15/16" (202 mm)	3.30 m	56 kg / m2	60 STC		-
Type X	2 x 5/8" (2 x 15.9 mm)	CW 2 1/2" (CW 64 mm)	7 15/16" (202 mm)	3.30 m	59 kg / m2	61 STC		2 hour

GW-R	2 x 1/2" (2 x 12.7 mm)	CW 3 1/2" (CW 89 mm)	9 7/16" (239 mm)	4.09 m	45 kg / m2	59 STC		-
Type X	2 x 1/2" (2 x 12.7 mm)	CW 3 1/2" (CW 89 mm)	9 7/16" (239 mm)	4.09 m	49 kg / m2	60 STC	75 mm	2 hour
GW-R	2 x 5/8" (2 x 15.9 mm)	CW 3 1/2" (CW 89 mm)	9 15/16" (252 mm)	4.09 m	56 kg / m2	60 STC		-
Type X	2 x 5/8" (2 x 15.9 mm)	CW 3 1/2" (CW 89 mm)	9 15/16" (252 mm)	4.09 m	59 kg / m2	61 STC		2 hour

GW-R	2 x 1/2" (2 x 12.7 mm)	CW 4 1/32" (CW 102 mm)	10 7/16" (265 mm)	4.48 m	45 kg / m2	60 STC		-
Type X	2 x 1/2" (2 x 12.7 mm)	CW 4 1/32" (CW 102 mm)	10 7/16" (265 mm)	4.48 m	49 kg / m2	61 STC	100 mm	2 hour
GW-R	2 x 5/8" (2 x 15.9 mm)	CW 4 1/32" (CW 102 mm)	10 15/16" (278 mm)	4.48 m	56 kg / m2	61 STC		-
Type X	2 x 5/8" (2 x 15.9 mm)	CW 4 1/32" (CW 102 mm)	10 15/16" (278 mm)	4.48 m	59 kg / m2	62 STC		2 hour

GW-R	2 x 1/2" (2 x 12.7 mm)	CW 5 63/64" (CW 152 mm)	14 3/8" (365 mm)	5.99 m	45 kg / m2	60 STC		-
Type X	2 x 1/2" (2 x 12.7 mm)	CW 5 63/64" (CW 152 mm)	14 3/8" (365 mm)	5.99 m	49 kg / m2	61 STC	150 mm	2 hour
GW-R	2 x 5/8" (2 x 15.9 mm)	CW 5 63/64" (CW 152 mm)	14 7/8" (378 mm)	5.99 m	56 kg / m2	61 STC		-
Type X	2 x 5/8" (2 x 15.9 mm)	CW 5 63/64" (CW 152 mm)	14 7/8" (378 mm)	5.99 m	59 kg / m2	62 STC		2 hour

For solutions requiring 240 Pa load and/or L/360 deflection criteria, please contact Knauf Technical Department. For wet areas, use of Knauf Water Resistant Board (GB-WR and GB-WRTX) is recommended.



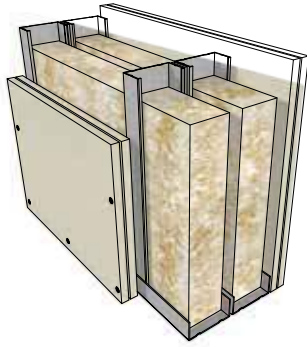

KW A115

SYSTEMS BUILD-UP

**Profile Thickness:
0.9 mm (20 Gauge)**

Board Type	Cladding thickness	Studs size	Total thickness	Max. Height	Approx. Weight	Sound Insulation (ASTM E90) STC	Min. Insulation thickness (min. 16 kg/m ³)	Fire rating (ASTM E119)
------------	--------------------	------------	-----------------	-------------	----------------	---------------------------------	--	-------------------------

Studs ASTM C645-00 Nonstructural Steel Framing Members, 20 Gauge (0.9 mm thick), flange 1.3 in. (33 mm), spacing 24 in. (610 mm)

GW-R	2 x 1/2" (2 x 12.7 mm)	CW 2 1/2" (CW 64 mm)	7 7/16" (189 mm)	3.93 m	45 kg / m ²	59 STC		-
Type X	2 x 1/2" (2 x 12.7 mm)	CW 2 1/2" (CW 64 mm)	7 7/16" (189 mm)	3.93 m	49 kg / m ²	60 STC	50 mm	2 hour
GW-R	2 x 5/8" (2 x 15.9 mm)	CW 2 1/2" (CW 64 mm)	7 15/16" (202 mm)	3.93 m	56 kg / m ²	60 STC		-
Type X	2 x 5/8" (2 x 15.9 mm)	CW 2 1/2" (CW 64 mm)	7 15/16" (202 mm)	3.93 m	59 kg / m ²	61 STC		2 hour

GW-R	2 x 1/2" (2 x 12.7 mm)	CW 3 1/2" (CW 89 mm)	9 7/16" (239 mm)	4.91 m	45 kg / m ²	59 STC		-
Type X	2 x 1/2" (2 x 12.7 mm)	CW 3 1/2" (CW 89 mm)	9 7/16" (239 mm)	4.91 m	49 kg / m ²	60 STC	75 mm	2 hour
GW-R	2 x 5/8" (2 x 15.9 mm)	CW 3 1/2" (CW 89 mm)	9 15/16" (252 mm)	4.91 m	56 kg / m ²	60 STC		-
Type X	2 x 5/8" (2 x 15.9 mm)	CW 3 1/2" (CW 89 mm)	9 15/16" (252 mm)	4.91 m	59 kg / m ²	61 STC		2 hour

GW-R	2 x 1/2" (2 x 12.7 mm)	CW 4 1/32" (CW 102 mm)	10 7/16" (265 mm)	5.39 m	45 kg / m ²	60 STC		-
Type X	2 x 1/2" (2 x 12.7 mm)	CW 4 1/32" (CW 102 mm)	10 7/16" (265 mm)	5.39 m	49 kg / m ²	61 STC	100 mm	2 hour
GW-R	2 x 5/8" (2 x 15.9 mm)	CW 4 1/32" (CW 102 mm)	10 15/16" (278 mm)	5.39 m	56 kg / m ²	61 STC		-
Type X	2 x 5/8" (2 x 15.9 mm)	CW 4 1/32" (CW 102 mm)	10 15/16" (278 mm)	5.39 m	59 kg / m ²	62 STC		2 hour

GW-R	2 x 1/2" (2 x 12.7 mm)	CW 5 63/64" (CW 152 mm)	14 3/8" (365 mm)	7.25 m	45 kg / m ²	60 STC		-
Type X	2 x 1/2" (2 x 12.7 mm)	CW 5 63/64" (CW 152 mm)	14 3/8" (365 mm)	7.25 m	49 kg / m ²	61 STC	150 mm	2 hour
GW-R	2 x 5/8" (2 x 15.9 mm)	CW 5 63/64" (CW 152 mm)	14 7/8" (378 mm)	7.25 m	56 kg / m ²	61 STC		-
Type X	2 x 5/8" (2 x 15.9 mm)	CW 5 63/64" (CW 152 mm)	14 7/8" (378 mm)	7.25 m	59 kg / m ²	62 STC		2 hour

For solutions requiring 240 Pa load and/or L / 360 deflection criteria, please contact Knauf Technical Department. For wet areas, use of Knauf Water Resistant Board (GB-WR and GB-WRTX) is recommended.

KW A116

CONNECTIONS AND JOINTS

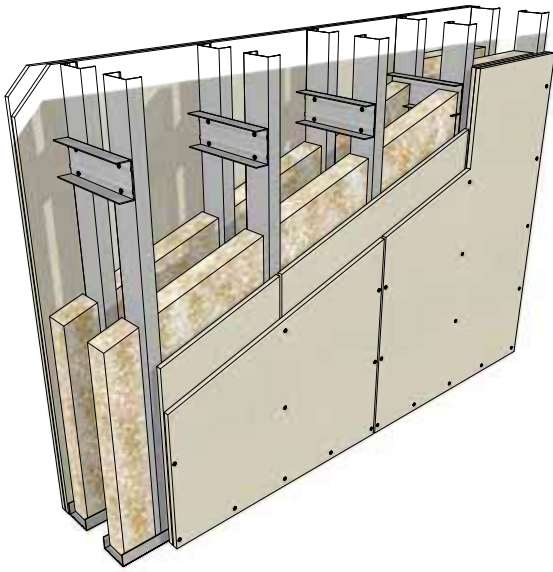

Structural Heights for 24"(609 mm) / 16"(406 mm) / 12"(304 mm) stud spacing

Maximum structural heights are calculated for a static wind load of 240 Pa (5 psf) at deflection criteria L/240.

Structural calculations available for L/360, please contact Technical Department for details.

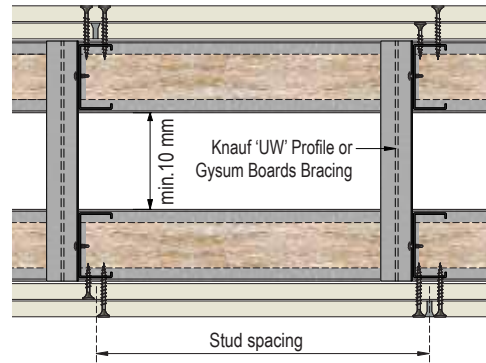

KW A116 Wall Connection

PLAN

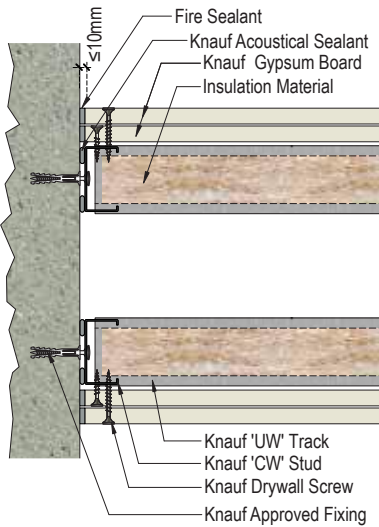

KW A116 Joint & Bracing

PLAN

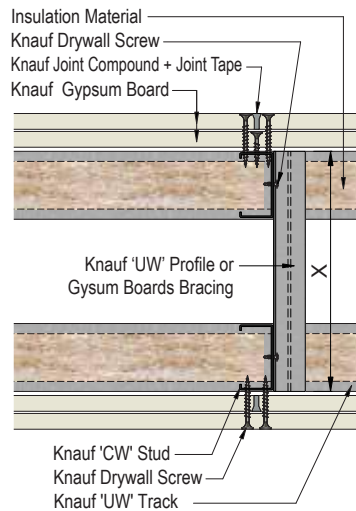

KW A116 Corner detail

PLAN

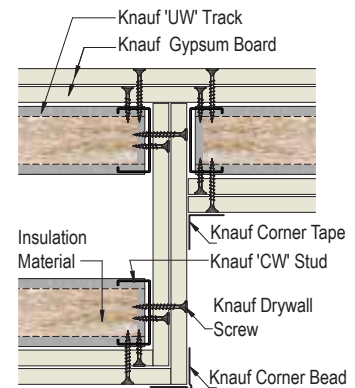

KW A116 Knauf floor connection

ELEVATION

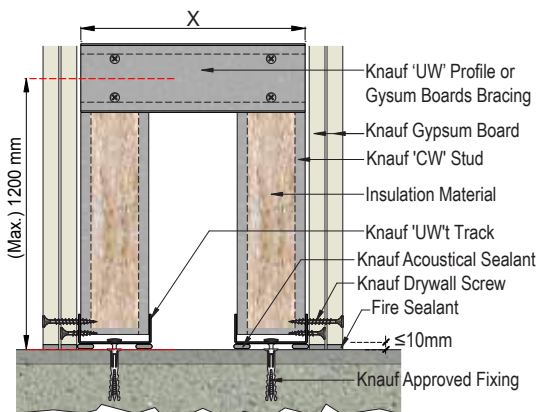

KW A116 Joint & Bracing

ELEVATION

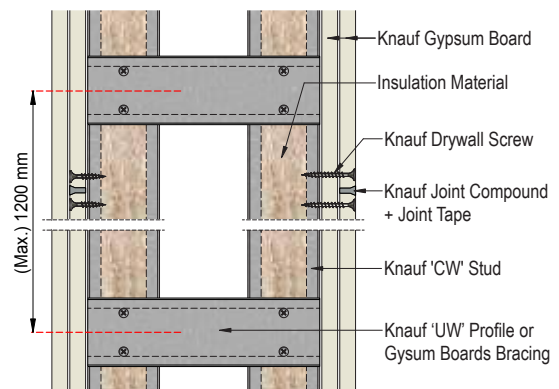

KW A116

DEFLECTION HEAD DETAILS

KW A116 Head connection, up to 10 mm deflection

ELEVATION

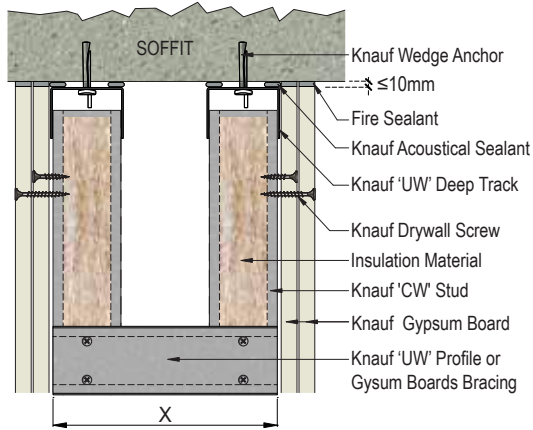

- Knauf Drywall systems can provide deflection up to 10 mm using the standard detail and standard flange UW track (1 inch / 25 mm)

KW A116 Head connection, up to ± 25 mm deflection

ELEVATION

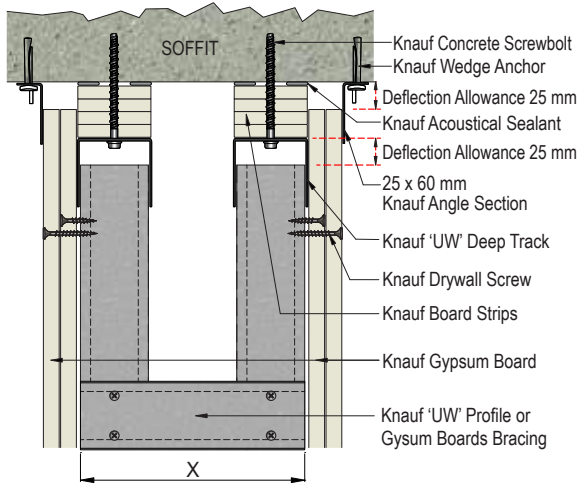

- Higher deflection requirement can be achieved using the tested head of wall (minimum stud size 2 1/2 inch – 64 mm)
- Fire Rating up to 2 hours (using GW-TX Type X boards 15.9mm)
- Deep Flange UW track 2-3/8 inch (60 mm)
- Steel angle : 25 GA (0.5 mm) galvanized steel with one leg measuring 1 in. (25 mm) and the other angle 3/8 in. (10 mm) longer than the maximum Head of Wall Joint opening.

Design Number KL/GBF 120-01

Head of Wall Joint / Knauf Fire Resistant Gypsum Board

ASTM E1966 / Fire Resistance Rating: 2 hrs

Maximum Joint Opening – 2 in. (50mm)

Minimum Joint Opening – 1 in. (25mm)

KW A116

SYSTEMS BUILD-UP

Profile Thickness:
0.5 mm (25 Gauge)

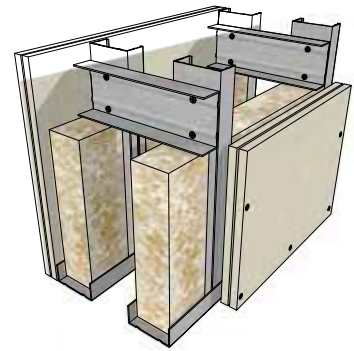

Board Type	Cladding thickness	Studs size	Min. thickness	Max. Height	Approx. Weight	Sound Insulation ⁽²⁾ (ASTM E90) STC	Min. Insulation thickness (min. 16 kg/m3)	Fire rating (ASTM E119)
------------	--------------------	------------	----------------	-------------	----------------	--	---	-------------------------

Studs ASTM C645-00 Nonstructural Steel Framing Members, 25 Gauge (0.5 mm thick), flange 1.3 in (33 mm), spacing 24 in. (610 mm)

GW-R	2 x 1/2" (2 x 12.7 mm)	CW 2 1/2" (CW 64 mm)	11 13/16" - 19 11/16" (300 - 500 mm)	7 - 16 m	45 kg / m2	56 STC	50 mm	-
Type X	2 x 1/2" (2 x 12.7 mm)	CW 2 1/2" (CW 64 mm)	11 13/16" - 19 11/16" (300 - 500 mm)		49 kg / m2	56 STC		1 hour
GW-R	2 x 5/8" (2 x 15.9 mm)	CW 2 1/2" (CW 64 mm)	11 13/16" - 19 11/16" (300 - 500 mm)		56 kg / m2	56 STC		-
Type X	2 x 5/8" (2 x 15.9 mm)	CW 2 1/2" (CW 64 mm)	11 13/16" - 19 11/16" (300 - 500 mm)		59 kg / m2	56 STC		2 hours ⁽¹⁾

GW-R	2 x 1/2" (2 x 12.7 mm)	CW 3 1/2" (CW 89 mm)	11 13/16" - 19 11/16" (300 - 500 mm)	7 - 16 m	45 kg / m2	56 STC	75 mm	-
Type X	2 x 1/2" (2 x 12.7 mm)	CW 3 1/2" (CW 89 mm)	11 13/16" - 19 11/16" (300 - 500 mm)		49 kg / m2	56 STC		1 hour
GW-R	2 x 5/8" (2 x 15.9 mm)	CW 3 1/2" (CW 89 mm)	11 13/16" - 19 11/16" (300 - 500 mm)		56 kg / m2	56 STC		-
Type X	2 x 5/8" (2 x 15.9 mm)	CW 3 1/2" (CW 89 mm)	11 13/16" - 19 11/16" (300 - 500 mm)		59 kg / m2	56 STC		2 hours

GW-R	2 x 1/2" (2 x 12.7 mm)	CW 4 1/32" (CW 102 mm)	11 13/16" - 19 11/16" (300 - 500 mm)	7 - 16 m	45 kg / m2	56 STC	100 mm	-
Type X	2 x 1/2" (2 x 12.7 mm)	CW 4 1/32" (CW 102 mm)	11 13/16" - 19 11/16" (300 - 500 mm)		49 kg / m2	56 STC		1 hour
GW-R	2 x 5/8" (2 x 15.9 mm)	CW 4 1/32" (CW 102 mm)	11 13/16" - 19 11/16" (300 - 500 mm)		56 kg / m2	56 STC		-
Type X	2 x 5/8" (2 x 15.9 mm)	CW 4 1/32" (CW 102 mm)	11 13/16" - 19 11/16" (300 - 500 mm)		59 kg / m2	56 STC		2 hours

GW-R	2 x 1/2" (2 x 12.7 mm)	CW 5 63/64" (CW 152 mm)	11 13/16" - 19 11/16" (300 - 500 mm)	7 - 16 m	45 kg / m2	56 STC	150 mm	-
Type X	2 x 1/2" (2 x 12.7 mm)	CW 5 63/64" (CW 152 mm)	11 13/16" - 19 11/16" (300 - 500 mm)		49 kg / m2	56 STC		2 hours
GW-R	2 x 5/8" (2 x 15.9 mm)	CW 5 63/64" (CW 152 mm)	11 13/16" - 19 11/16" (300 - 500 mm)		56 kg / m2	56 STC		-
Type X	2 x 5/8" (2 x 15.9 mm)	CW 5 63/64" (CW 152 mm)	11 13/16" - 19 11/16" (300 - 500 mm)		59 kg / m2	56 STC		2 hours

(1) As per Gypsum Association – Fire Resistance Design Manual GA-600-2012, GA file no. WP 5105.

(2) Sound rating value can be improved by using the Knauf V-Brace connection. Please contact Knauf Technical Department for further information.

For solutions requiring 240 Pa load and/or L / 360 deflection criteria, please contact Knauf Technical Department. For wet areas, use of Knauf Water Resistant Board (GB-WR and GB-WRTX) is recommended.

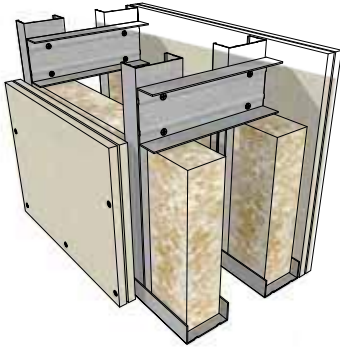

KW A116 SYSTEMS BUILD-UP

Profile Thickness:
0.9 mm (20 Gauge)

Board Type	Cladding thickness	Studs size	Min. thickness	Max. Height	Approx. Weight	Sound Insulation ⁽²⁾ (ASTM E90) STC	Min. Insulation thickness (min. 16 kg/m ³)	Fire rating (ASTM E119)
------------	--------------------	------------	----------------	-------------	----------------	--	--	-------------------------

Studs ASTM C645-00 Nonstructural Steel Framing Members, 20 Gauge (0.9 mm thick), flange 1.3 in. (33 mm), spacing 24 in. (610 mm)

GW-R	2 x 1/2" (2 x 12.7 mm)	CW 2 1/2" (CW 64 mm)	11 13/16" - 19 11/16" (300 - 500 mm)	11 - 20 m	45 kg / m ²	56 STC	50 mm	-
Type X	2 x 1/2" (2 x 12.7 mm)	CW 2 1/2" (CW 64 mm)	11 13/16" - 19 11/16" (300 - 500 mm)		49 kg / m ²	56 STC		2 hours
GW-R	2 x 5/8" (2 x 15.9 mm)	CW 2 1/2" (CW 64 mm)	11 13/16" - 19 11/16" (300 - 500 mm)		56 kg / m ²	56 STC	-	
Type X	2 x 5/8" (2 x 15.9 mm)	CW 2 1/2" (CW 64 mm)	11 13/16" - 19 11/16" (300 - 500 mm)		59 kg / m ²	56 STC	2 hours ⁽¹⁾	

GW-R	2 x 1/2" (2 x 12.7 mm)	CW 3 1/2" (CW 89 mm)	11 13/16" - 19 11/16" (300 - 500 mm)	11 - 20 m	45 kg / m ²	56 STC	75 mm	-
Type X	2 x 1/2" (2 x 12.7 mm)	CW 3 1/2" (CW 89 mm)	11 13/16" - 19 11/16" (300 - 500 mm)		49 kg / m ²	56 STC		2 hours
GW-R	2 x 5/8" (2 x 15.9 mm)	CW 3 1/2" (CW 89 mm)	11 13/16" - 19 11/16" (300 - 500 mm)		56 kg / m ²	56 STC	-	
Type X	2 x 5/8" (2 x 15.9 mm)	CW 3 1/2" (CW 89 mm)	11 13/16" - 19 11/16" (300 - 500 mm)		59 kg / m ²	56 STC	2 hours	

GW-R	2 x 1/2" (2 x 12.7 mm)	CW 4 1/32" (CW 102 mm)	11 13/16" - 19 11/16" (300 - 500 mm)	11 - 20 m	45 kg / m ²	56 STC	100 mm	-
Type X	2 x 1/2" (2 x 12.7 mm)	CW 4 1/32" (CW 102 mm)	11 13/16" - 19 11/16" (300 - 500 mm)		49 kg / m ²	56 STC		2 hours
GW-R	2 x 5/8" (2 x 15.9 mm)	CW 4 1/32" (CW 102 mm)	11 13/16" - 19 11/16" (300 - 500 mm)		56 kg / m ²	56 STC	-	
Type X	2 x 5/8" (2 x 15.9 mm)	CW 4 1/32" (CW 102 mm)	11 13/16" - 19 11/16" (300 - 500 mm)		59 kg / m ²	56 STC	2 hours	

GW-R	2 x 1/2" (2 x 12.7 mm)	CW 5 63/64" (CW 152 mm)	11 13/16" - 19 11/16" (300 - 500 mm)	11 - 20 m	45 kg / m ²	56 STC	150 mm	-
Type X	2 x 1/2" (2 x 12.7 mm)	CW 5 63/64" (CW 152 mm)	11 13/16" - 19 11/16" (300 - 500 mm)		49 kg / m ²	56 STC		2 hours
GW-R	2 x 5/8" (2 x 15.9 mm)	CW 5 63/64" (CW 152 mm)	11 13/16" - 19 11/16" (300 - 500 mm)		56 kg / m ²	56 STC	-	
Type X	2 x 5/8" (2 x 15.9 mm)	CW 5 63/64" (CW 152 mm)	11 13/16" - 19 11/16" (300 - 500 mm)		59 kg / m ²	56 STC	2 hours	

(1) As per Gypsum Association – Fire Resistance Design Manual GA-600-2012, GA file no. WP 5105.

(2) Sound rating value can be improved by using the Knauf V-Brace connection. Please contact Knauf Technical Department for further information.

For solutions requiring 240 Pa load and/or L/360 deflection criteria, please contact Knauf Technical Department. For wet areas, use of Knauf Water Resistant Board (GB-WR and GB-WRTX) is recommended.

KW A/S115

CONNECTIONS AND JOINTS (Staggered Stud System)

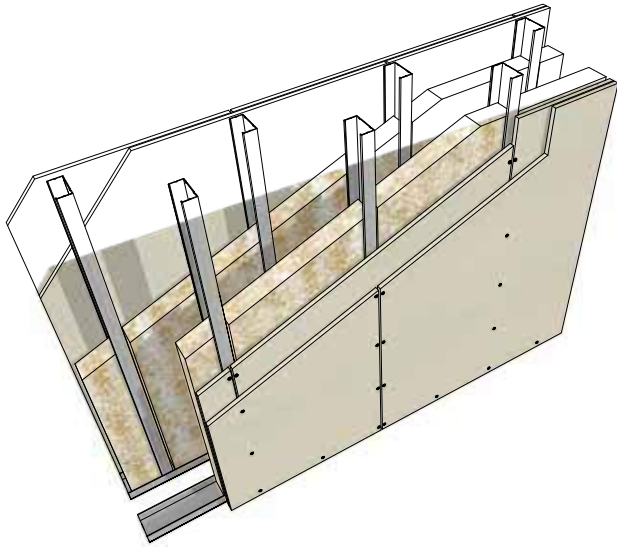

Structural Heights for 24"(609 mm) / 16"(406 mm) / 12"(304 mm) stud spacing

Maximum structural heights are calculated for a static wind load of 240 Pa (5 psf) at deflection criteria L/240.

Structural calculations available for L/360, please contact Technical Department for details.

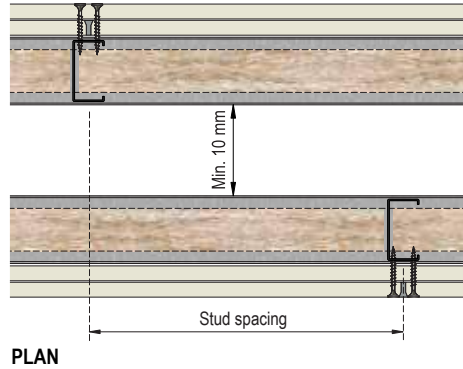

PLAN

KW A/S115 Wall Connection

PLAN

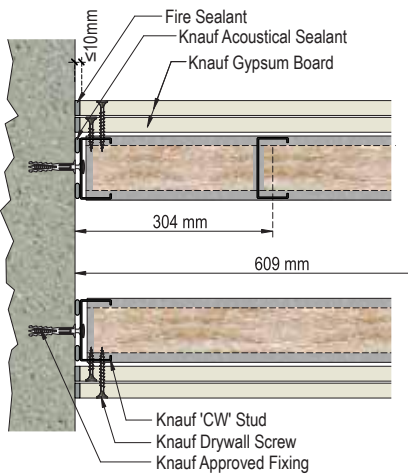

KW A/S115 Joint

PLAN

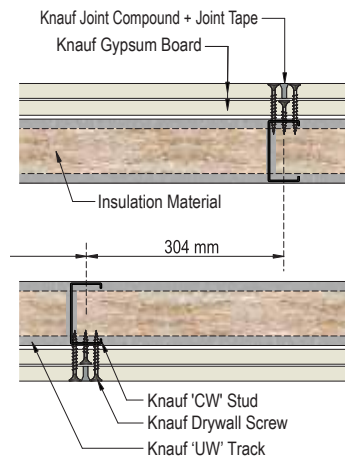

KW A/S115 Corner detail

PLAN

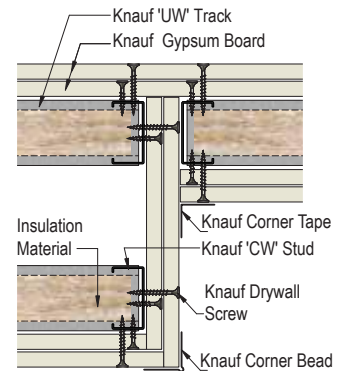

KW A/S115 Knauf floor connection

ELEVATION

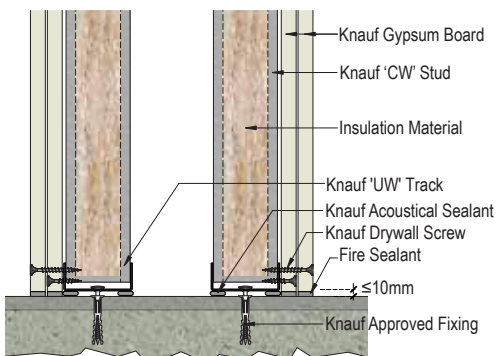

KW A/S115 Joint

ELEVATION

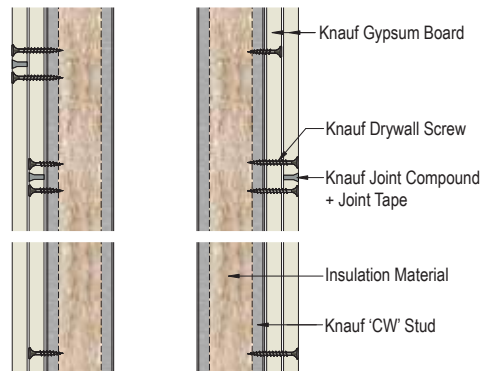

KW A/S115

SPACING & HEIGHT

Stud size	Stud Spacing (center to center)	Max. Structural Height	
		25 GA (0.5 mm thick)	20 GA (0.9 mm thick)
CW 1 5/8" / (CW 41 mm)	16" (406 mm)	-	-
	12" (304 mm)	-	-
CW 2 1/2" / (CW 64 mm)	24" (609 mm)	3.30 m	3.93 m
	16" (406 mm)	3.78 m	4.50 m
CW 1 5/8" / (CW 89 mm)	12" (304 mm)	4.14 m	4.92 m
	24" (609 mm)	4.09 m	4.91 m
CW 2 1/2" / (CW 102 mm)	16" (406 mm)	4.74 m	5.68 m
	12" (304 mm)	5.23 m	6.23 m
CW 2 1/2" / (CW 152 mm)	24" (609 mm)	4.48 m	5.39 m
	16" (406 mm)	5.22 m	6.25 m
CW 2 1/2" / (CW 152 mm)	12" (304 mm)	5.74 m	6.86 m
	24" (609 mm)	5.99 m	7.25 m
CW 2 1/2" / (CW 152 mm)	16" (406 mm)	7.04 m	8.44 m
	12" (304 mm)	7.76 m	9.29 m

KW A/S115 Head connection, up to 10 mm deflection

ELEVATION

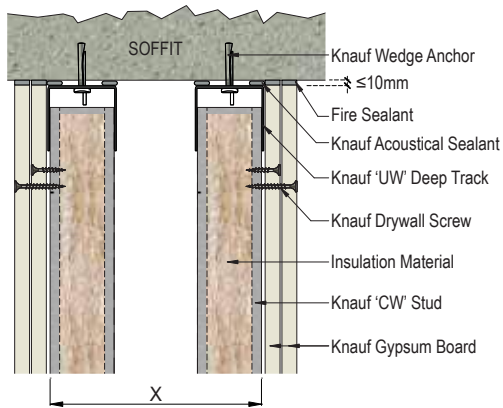

- Knauf Drywall systems can provide deflection up to 10 mm using the standard detail and standard flange UW track (1 inch / 25 mm)

KW A/S115 Head connection, up to ± 25 mm deflection

ELEVATION

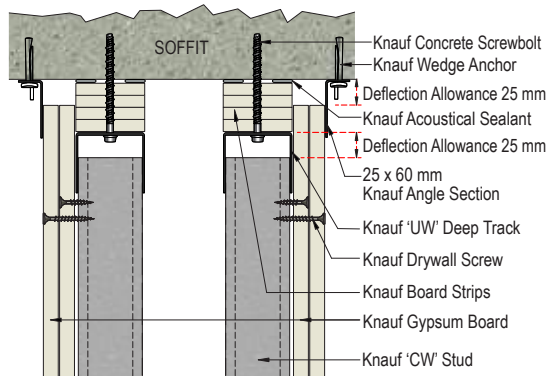

- Higher deflection requirement can be achieved using the tested head of wall (minimum stud size 2 1/2 inch – 64 mm)
- Fire Rating up to 2 hours (using GW-TX Type X boards 15.9mm)
- Deep Flange UW track 2-3/8 inch (60 mm)
- Steel angle : 25 GA (0.5 mm) galvanized steel with one leg measuring 1 in. (25 mm) and the other angle 3/8 in. (10 mm) longer than the maximum Head of Wall Joint opening.

Design Number KL/GBF 120-01

Head of Wall Joint / Knauf Fire Resistant Gypsum Board

ASTM E1966 / Fire Resistance Rating: 2 hrs

Maximum Joint Opening – 2 in. (50mm)

Minimum Joint Opening – 1 in. (25mm)

KW A/S115

SYSTEMS BUILD-UP

Profile Thickness:
0.5 mm (25 Gauge)

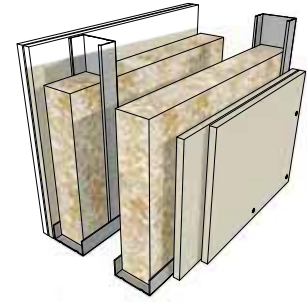

Board Type	Cladding thickness	Studs size	Min. thickness	Max. Height	Approx. Weight	Sound Insulation (ASTM E90) STC	Min. Insulation thickness (min. 16 kg/m3)	Fire rating (ASTM E119)
------------	--------------------	------------	----------------	-------------	----------------	---------------------------------	---	-------------------------

Studs ASTM C645-00 Nonstructural Steel Framing Members, 25 Gauge (0.5 mm thick), flange 1.3 in (33 mm), spacing 24 in. (610 mm)

GW-R	2 x 1/2" (2 x 12.7 mm)	CW 2 1/2" (CW 64 mm)	7 7/16" (189 mm)	3.30 m	45 kg / m2	61 STC		-
Type X	2 x 1/2" (2 x 12.7 mm)	CW 2 1/2" (CW 64 mm)	7 7/16" (189 mm)	3.30 m	49 kg / m2	62 STC		2 hours
GW-R	2 x 5/8" (2 x 15.9 mm)	CW 2 1/2" (CW 64 mm)	7 15/16" (202 mm)	3.30 m	56 kg / m2	62 STC	50 mm	-
Type X	2 x 5/8" (2 x 15.9 mm)	CW 2 1/2" (CW 64 mm)	7 15/16" (202 mm)	3.30 m	59 kg / m2	63 STC		2 hours

GW-R	2 x 1/2" (2 x 12.7 mm)	CW 3 1/2" (CW 89 mm)	9 7/16" (239 mm)	4.09 m	45 kg / m2	61 STC		-
Type X	2 x 1/2" (2 x 12.7 mm)	CW 3 1/2" (CW 89 mm)	9 7/16" (239 mm)	4.09 m	49 kg / m2	62 STC		2 hours
GW-R	2 x 5/8" (2 x 15.9 mm)	CW 3 1/2" (CW 89 mm)	9 15/16" (252 mm)	4.09 m	56 kg / m2	62 STC	75 mm	-
Type X	2 x 5/8" (2 x 15.9 mm)	CW 3 1/2" (CW 89 mm)	9 15/16" (252 mm)	4.09 m	59 kg / m2	63 STC		2 hours

GW-R	2 x 1/2" (2 x 12.7 mm)	CW 4 1/32" (CW 102 mm)	10 7/16" (265mm)	4.48 m	45 kg / m2	62 STC		-
Type X	2 x 1/2" (2 x 12.7 mm)	CW 4 1/32" (CW 102 mm)	10 7/16" (265mm)	4.48 m	49 kg / m2	63 STC		2 hours
GW-R	2 x 5/8" (2 x 15.9 mm)	CW 4 1/32" (CW 102 mm)	10 15/16" (278 mm)	4.48 m	56 kg / m2	63 STC	100 mm	-
Type X	2 x 5/8" (2 x 15.9 mm)	CW 4 1/32" (CW 102 mm)	10 15/16" (278 mm)	4.48 m	59 kg / m2	65 STC		2 hours

GW-R	2 x 1/2" (2 x 12.7 mm)	CW 5 63/64" (CW 152 mm)	14 3/8" (365 mm)	5.99 m	45 kg / m2	62 STC		-
Type X	2 x 1/2" (2 x 12.7 mm)	CW 5 63/64" (CW 152 mm)	CW 14 3/8" (365 mm)	5.99 m	49 kg / m2	63 STC		2 hours
GW-R	2 x 5/8" (2 x 15.9 mm)	CW 5 63/64" (CW 152 mm)	14 7/8" (378 mm)	5.99 m	56 kg / m2	63 STC	150 mm	-
Type X	2 x 5/8" (2 x 15.9 mm)	CW 5 63/64" (CW 152 mm)	14 7/8" (378 mm)	5.99 m	59 kg / m2	65 STC		2 hours

For solutions requiring 240 Pa load and/or L/ 360 deflection criteria, please contact Knauf Technical Department. For wet areas, use of Knauf Water Resistant Board (GB-WR and GB-WRTX) is recommended.

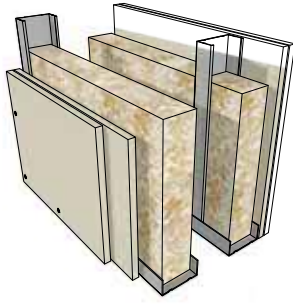

KW A/S115

SYSTEMS BUILD-UP

Profile Thickness:
0.9 mm (20 Gauge)

Board Type	Cladding thickness	Studs size	Min. thickness	Max. Height	Approx. Weight	Sound Insulation (ASTM E90) STC	Min. Insulation thickness (min. 16 kg/m ³)	Fire rating (ASTM E119)
------------	--------------------	------------	----------------	-------------	----------------	---------------------------------	--	-------------------------

Studs ASTM C645-00 Nonstructural Steel Framing Members, 20 Gauge (0.9 mm thick), flange 1.3 in. (33 mm), spacing 24 in. (610 mm)

GW-R	2 x 1/2" (2 x 12.7 mm)	CW 2 1/2" (CW 64 mm)	7 7/16" (189 mm)	3.93 m	45 kg / m ²	61 STC		-
Type X	2 x 1/2" (2 x 12.7 mm)	CW 2 1/2" (CW 64 mm)	7 7/16" (189 mm)	3.93 m	49 kg / m ²	62 STC		2 hours
GW-R	2 x 5/8" (2 x 15.9 mm)	CW 2 1/2" (CW 64 mm)	7 15/16" (202 mm)	3.93 m	56 kg / m ²	62 STC	50 mm	-
Type X	2 x 5/8" (2 x 15.9 mm)	CW 2 1/2" (CW 64 mm)	7 15/16" (202 mm)	3.93 m	59 kg / m ²	63 STC		2 hours

GW-R	2 x 1/2" (2 x 12.7 mm)	CW 3 1/2" (CW 89 mm)	9 7/16" (239 mm)	4.91 m	45 kg / m ²	61 STC		-
Type X	2 x 1/2" (2 x 12.7 mm)	CW 3 1/2" (CW 89 mm)	9 7/16" (239 mm)	4.91 m	49 kg / m ²	62 STC		2 hours
GW-R	2 x 5/8" (2 x 15.9 mm)	CW 3 1/2" (CW 89 mm)	9 15/16" (252 mm)	4.91 m	56 kg / m ²	62 STC	75 mm	-
Type X	2 x 5/8" (2 x 15.9 mm)	CW 3 1/2" (CW 89 mm)	9 15/16" (252 mm)	4.91 m	59 kg / m ²	63 STC		2 hours

GW-R	2 x 1/2" (2 x 12.7 mm)	CW 4 1/32" (CW 102 mm)	10 7/16" (265mm)	5.39 m	45 kg / m ²	62 STC		-
Type X	2 x 1/2" (2 x 12.7 mm)	CW 4 1/32" (CW 102 mm)	10 7/16" (265mm)	5.39 m	49 kg / m ²	63 STC		2 hours
GW-R	2 x 5/8" (2 x 15.9 mm)	CW 4 1/32" (CW 102 mm)	10 15/16" (278 mm)	5.39 m	56 kg / m ²	63 STC	100 mm	-
Type X	2 x 5/8" (2 x 15.9 mm)	CW 4 1/32" (CW 102 mm)	10 15/16" (278 mm)	5.39 m	59 kg / m ²	65 STC		2 hours

GW-R	2 x 1/2" (2 x 12.7 mm)	CW 5 63/64" (CW 152 mm)	14 3/8" (365 mm)	7.25 m	45 kg / m ²	62 STC		-
Type X	2 x 1/2" (2 x 12.7 mm)	CW 5 63/64" (CW 152 mm)	CW 14 3/8" (365 mm)	7.25 m	49 kg / m ²	63 STC		2 hours
GW-R	2 x 5/8" (2 x 15.9 mm)	CW 5 63/64" (CW 152 mm)	14 7/8" (378 mm)	7.25 m	56 kg / m ²	63 STC	150 mm	-
Type X	2 x 5/8" (2 x 15.9 mm)	CW 5 63/64" (CW 152 mm)	14 7/8" (378 mm)	7.25 m	59 kg / m ²	65 STC		2 hours

For solutions requiring 240 Pa load and/or L/ 360 deflection criteria, please contact Knauf Technical Department. For wet areas, use of Knauf Water Resistant Board (GB-WR and GB-WRTX) is recommended.



SHAFTWALL

Knauf Shaftwall is our innovative system to form enclosures around service and lift shafts whilst working from one side. The unique Knauf 'C-T' Stud makes this possible with a minimum of components.





Shaftwall Partitions

Knauf Shaftwall is perfect for all situations where access from one side is restricted, giving a high fire performance whilst being simple to construct.



SHAFTWALL

The Knauf Shaft wall system is designed for use within elevator shafts and stairwell areas that prove to be a vital life safety link in multi-story buildings. These walls act as the main fire protection barrier against fire, they help to prevent fire entering the lift shaft and spreading rapidly from floor to floor.

Shaft wall Systems provide one or two hour fire resistance ratings in non-load bearing configurations. The system is designed to withstand the continuous surge of air pressure caused by fast moving elevators. These systems are constructed using the Knauf CT and J-Track channels that support the 1" (25.4mm) Type X core board and both the 1/2" (12.7mm) and 5/8" (15.9mm) Type X gypsum boards.

ELIMINATE THE NEED TO BUILD EXTENSIVE SCAFFOLDING.

The 610 mm wide Type X Core board makes installation fast & easy as it friction fits within the CT Stud and automatically provides a 24" (610 mm) o.c spacing ready for the cladding of the Type X gypsum board on the outer face. Shaft walls can be erected from one side, eliminating the need to build extensive scaffolding.

KSW A60 (Shaftwall Single Layer)

CONNECTIONS AND JOINTS

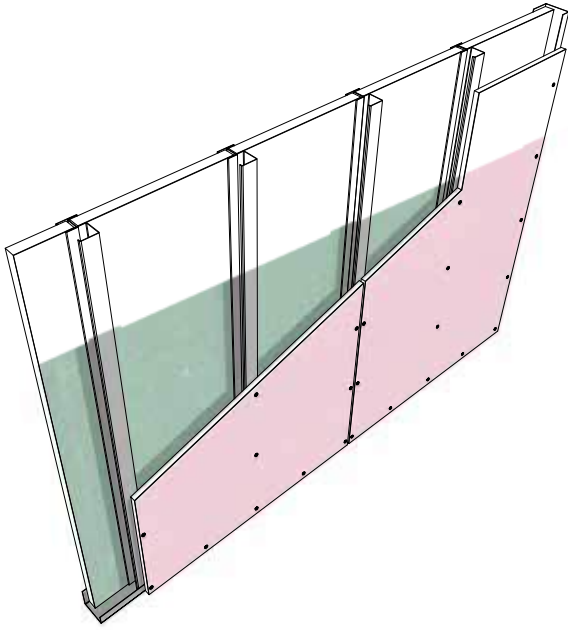

Structural Heights for 610 mm stud spacing

Maximum structural heights are calculated for a static wind load of 240 Pa (5 psf) at deflection criteria L/240.

Structural calculations available for 360 Pa (7.5 psf), 480 Pa (10 psf). Also available structural calculations for deflection criteria L/360.

Please contact Technical Department for details.

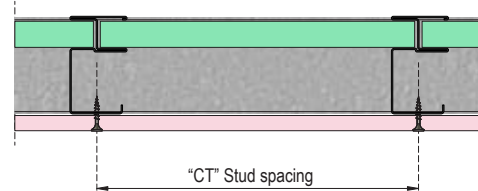

PLAN

"CT" Stud spacing

KSW A60 Wall Connection

PLAN

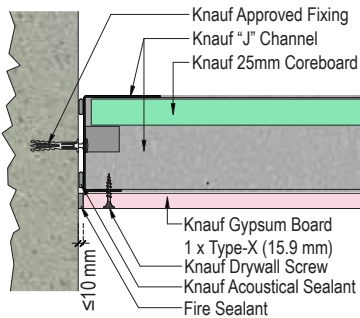

KSW A60 Knauf floor connection

ELEVATION

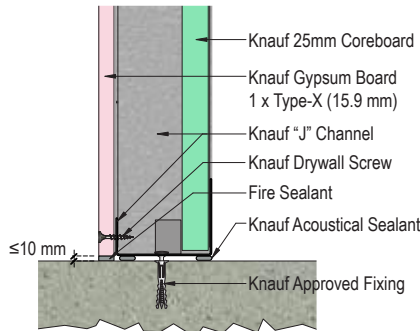

KSW A60 Joint connection

PLAN

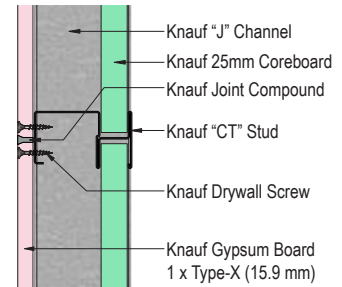

KSW A60 T-Junction

PLAN

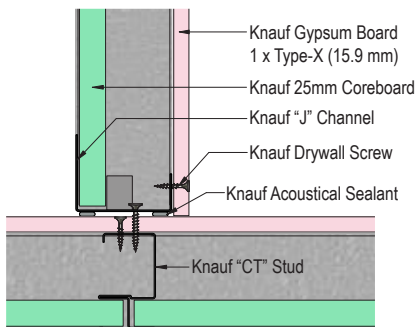

KSW A60 Corner Detail

PLAN

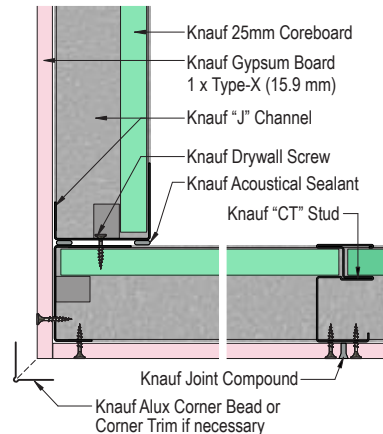

Shaftwall Head connection, up to 10 mm deflection

ELEVATION

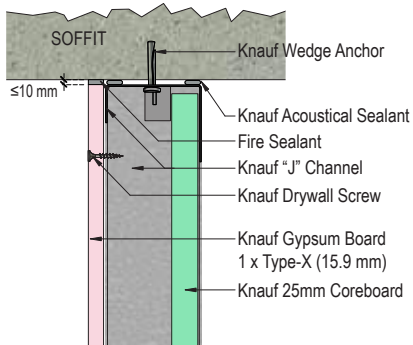

Shaftwall Corner Detail - alternative

PLAN

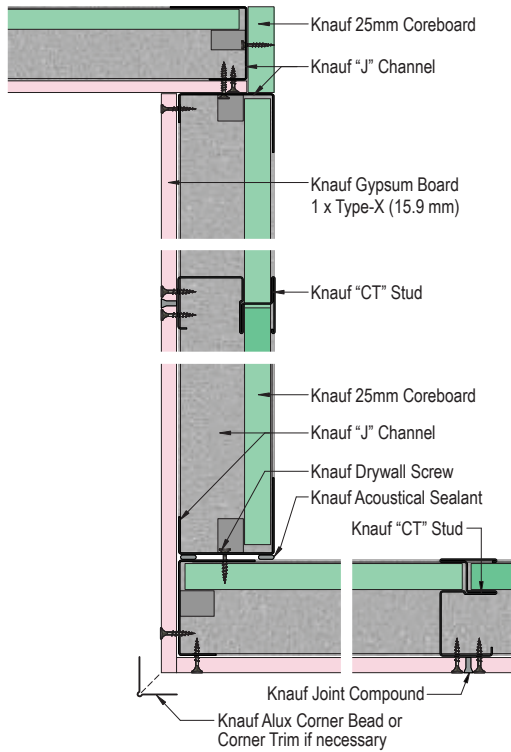

KSW A120 (Shaftwall Double Layer)

CONNECTIONS AND JOINTS

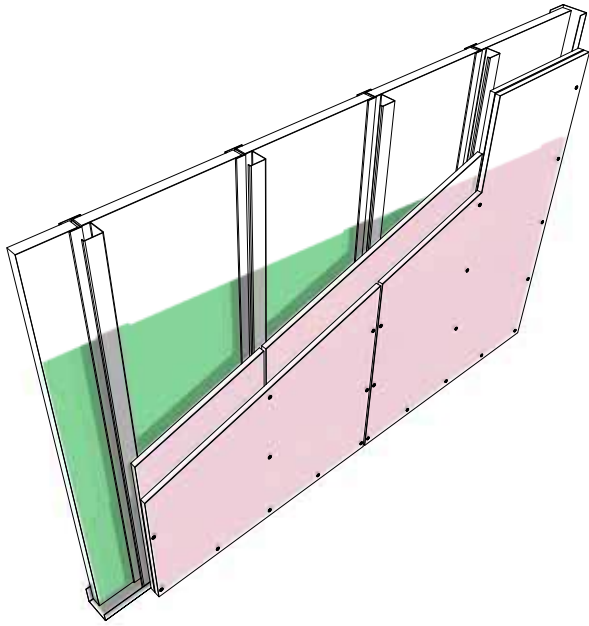

Structural Heights for 610 mm stud spacing

Maximum structural heights are calculated for a static wind load of 240 Pa (5 psf) at deflection criteria L/240.

Structural calculations available for 360 Pa (7.5 psf), 480 Pa (10 psf). Also available structural calculations for deflection criteria L/360.

Please contact Technical Department for details.

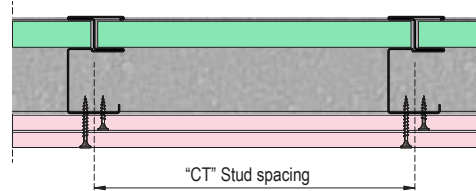

PLAN

"CT" Stud spacing

Shaftwall Wall Connection

PLAN

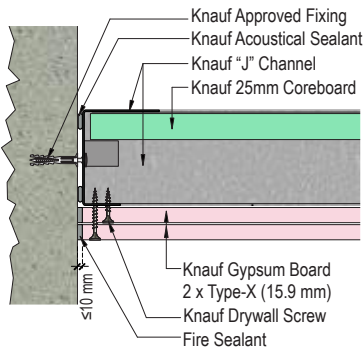

Shaftwall Knauf floor connection

ELEVATION

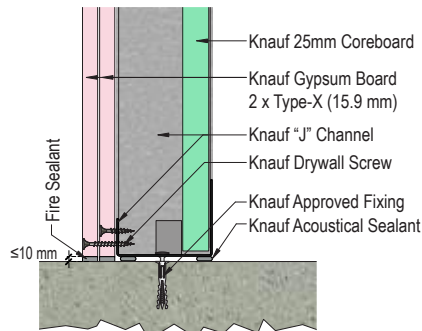

Shaftwall Joint connection

PLAN

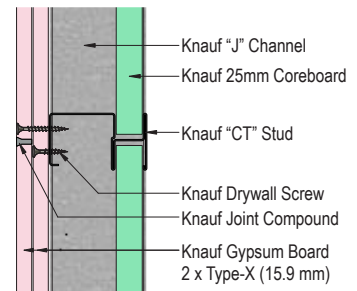

Shaftwall T-Junction

PLAN

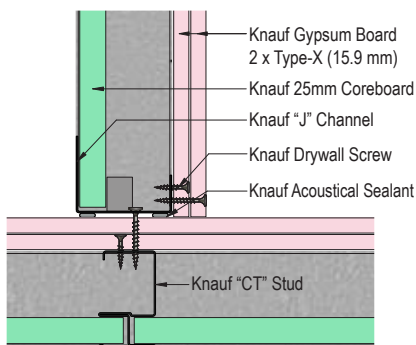

Shaftwall Corner Detail

PLAN

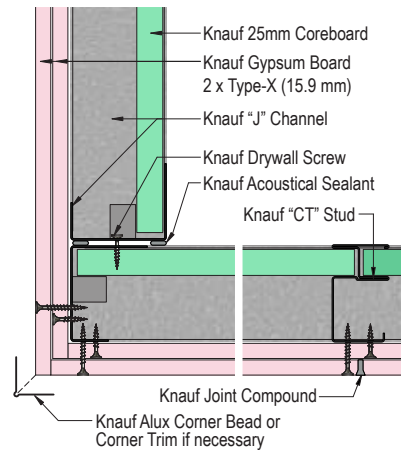

Shaftwall Head connection, up to 10 mm deflection

ELEVATION

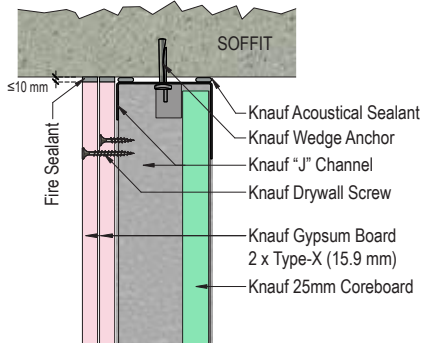

Shaftwall Corner Detail - alternative

PLAN

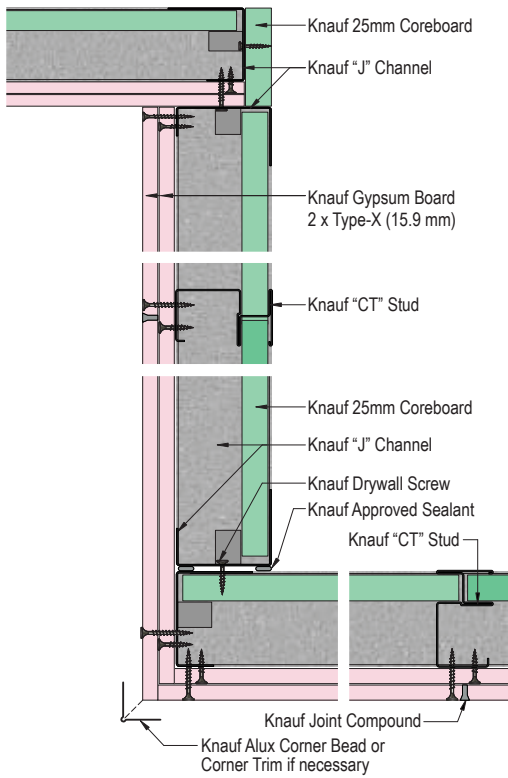

SHAFTWALL

SYSTEM BUILT-UP

- Knauf Drywall systems can provide deflection up to 10mm using the standard detail and standard flange UW track (1 inch / 25 mm)
- Higher deflection requirement can be achieved using the tested head of wall (minimum stud size 2 1/2 inch – 64 mm)
- Fire Rating up to 2 hours (using GW-TX Type X boards 15.9mm)
- Deep Flange UW track 2-3/8 inch (60 mm)
- Steel angle : 25 GA (0.5 mm) galvanized steel with one leg measuring 1 in. (25 mm) and the other angle 3/8 in. (10 mm) longer than the maximum Head of Wall Joint opening.

Design Number KL/GBF 120-03

Head of Wall Joint / Knauf Fire Resistant Gypsum Board

ASTM E1966 / Fire Resistance Rating: 2 hrs

Maximum Joint Opening – 2 in. (50mm)

Minimum Joint Opening – 1 in. (25mm)

Shaftwall Head connection, up to 25 mm deflection

ELEVATION

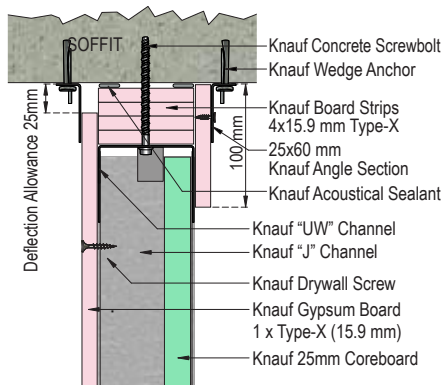

KSW A60

ELEVATION

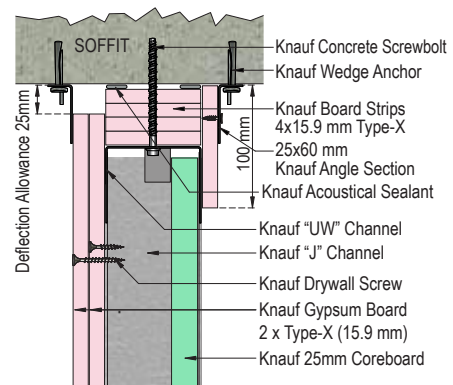

KSW A120

KSW A60 (Shaftwall Single Layer)

SYSTEM BUILT-UP

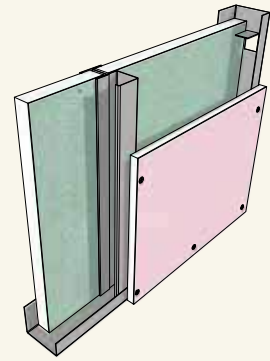

Board Type	Cladding thickness	Studs size	Total thickness	Max. Height	Approx. Weight	Sound Insulation (ASTM E90) STC	Min. Insulation thickness (min. 16 kg/m3)
------------	--------------------	------------	-----------------	-------------	----------------	---------------------------------	---

Studs ASTM C645-00 Nonstructural Steel Framing Members, 20 Gauge (0.9 mm thick), (33 mm), spacing 24 in. (610 mm)

GW-TX (Type X)	1 x 5/8" (1 x 15.9 mm)	CT 2 1/2" (CT 64 mm)	3 1/8" (80 mm)	4.00 m	45 kg / m2	40 STC	50 mm
GW-TX (Type X)	1 x 5/8" (1 x 15.9 mm)	CT 4 1/32" (CT 102 mm)	4 5/8" (118 mm)	5.30 m	45 kg / m2	43 STC	70 mm
GW-TX (Type X)	1 x 5/8" (1 x 15.9 mm)	CT 5 63/64" (CT 152 mm)	6 5/8" (168 mm)	7.10 m	45 kg / m2	44 STC	100 mm

1 Hour Shaft wall system

1" [25.4mm] Knauf Type X Core board is friction fitted between 2-1/2" [64mm], 4" [102mm] or 6" [152mm] C-T Studs this creating a studs spacing of 24" (610mm) on centers. One layer of 5/8" [15.9mm] Knauf Type X gypsum board is then applied vertically to outer face of the C-T stud framing and fixed using 1" (25mm) TB screws 12" (304mm) on Centers. All joints and screw heads should be finished with the Knauf Readygips Joint filler.

KSW A120 (Shaftwall Double Layer)

SYSTEM BUILT-UP

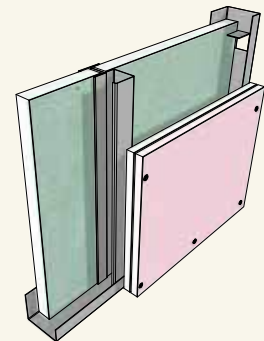

Board Type	Cladding thickness	Studs size	Total thickness	Max. Height	Approx. Weight	Sound Insulation (ASTM E90) STC	Min. Insulation thickness (min. 16 kg/m3)	Fire rating (ASTM E119) (ASTM E226)
------------	--------------------	------------	-----------------	-------------	----------------	---------------------------------	---	-------------------------------------

Studs ASTM C645-00 Nonstructural Steel Framing Members, 20 Gauge (0.9 mm thick), (33 mm), spacing 24 in. (610 mm)

GW-TX (Type X)	2 x 5/8" (2 x 15.9 mm)	CT 2 1/2" (CT 64 mm)	3 3/4" (96 mm)	4.50 m	47 kg / m2	45 STC	50 mm	2 hour
GW-TX (Type X)	2 x 5/8" (2 x 15.9 mm)	CT 4 1/32" (CT 102 mm)	5 1/4" (134 mm)	5.90 m	47 kg / m2	47 STC	75 mm	2 hour
GW-TX (Type X)	2 x 5/8" (2 x 15.9 mm)	CT 5 63/64" (CT 152 mm)	7 1/4" (184 mm)	7.90 m	47 kg / m2	48 STC	100 mm	2 hour

2 Hour Shaft wall system

1"[25.4mm] Knauf Type X Core board is friction fitted between 2-1/2"[64mm], 4"[102mm] or 6"[152mm] C-T Studs this creating a studs spacing of 24" (610mm) on centers. The first layer of 5/8"[15.9mm] Knauf Type X gypsum board is then applied vertically to outer face of the C-T stud framing and fixed using 1" (25mm) TB screws 12" (304mm) on Centers. The second layer of Knauf 5/8" (15.9mm) Type X Gypsum board is applied vertically (staggered joints from first layer) and fixed using 1-3/4" (45mm) TB screws 12" (304mm) on Centers. All joints and screw heads should be finished with the Knauf Readygips Joint filler.

GENERAL REQUIREMENTS

JOINTING

- Jointing should be done with joint compound Knauf Readygips and Knauf Joint Tape.
- On double layer partitions, jointing can be done only for the outer layer.

CONNECTIONS SEALING

- For acoustic requirements, seal the perimeter connections with acoustical sealant. Prior to fixing the perimeter tracks and studs, apply acoustical sealant on the backside.
- For fire requirements, seal the perimeter connections with fire sealant tested according to required standard.

FIRE PENETRATION

- Use approved fire penetration details and sealants.
- M&E cabling can be inserted through Knauf CW studs.
- Insulation materials such as rock wool, glass wool, EPS should be installed within the CW studs.
- The insulation can be fixed either friction fit or fixed securely by other means.
- Once the insulation + cabling work is finished, the board on the other side of partition should be cladded
- Power sockets, switch sockets, splitter sockets etc. are allowed to be installed at any position.
- In systems with sound requirements, do not install power sockets opposite to each other.
- Electrical socket boxes can be formed by using punching tools.
- For fire rated systems, the socket must be fire rated with minimum the same fire rating as the partition.

CONTROL JOINTS

- At maximum 9 m.
- At all control/ expansion joints present in the structure
- At any change in the substrate material

Fire Rating up to 1 hour using GW-TX Type X boards

- 1/2 inch metal or vinyl control joint accessory stapled to the wall on each side of the control joint opening. GA file no. SRS 1101.

Fire Rating up to 2 hours using GW-TX Type X boards

- 1/2 inch metal or vinyl control joint accessory stapled to the wall on each side of the control joint opening. GA file no. SRS 1201.

KW A111 Control Joint, fire rated, up to 1 hour

PLAN

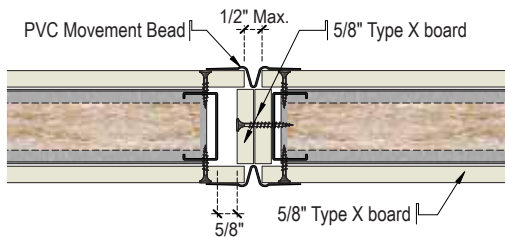

KW A112 Control Joint, fire rated, up to 2 hours

PLAN

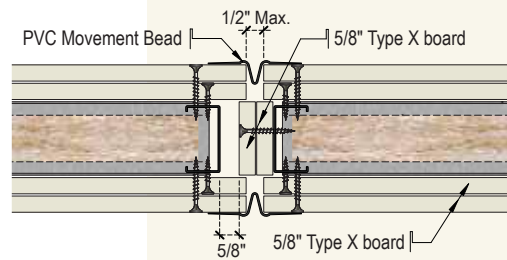

KW A116 & KW A/S115 (Control Joint, fire rated, up to 2 hours)

PLAN

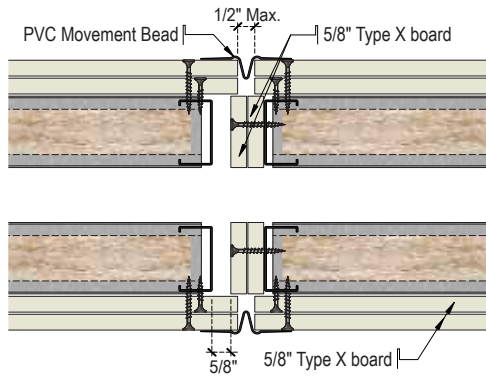

KW A115 Control Joint, fire rated, up to 2 hours

PLAN

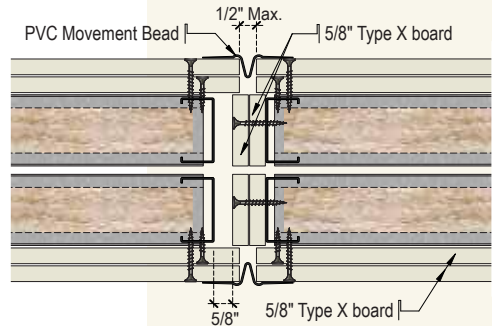

**KSW A60 (Shaftwall Single Layer)
Control Joint, fire rated, up to 1 hours**

PLAN

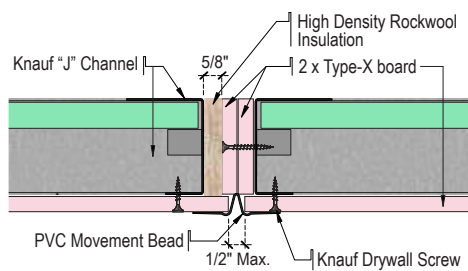

**KSW A120 (Shaftwall Double Layer)
Control Joint, fire rated, up to 2 hours**

PLAN

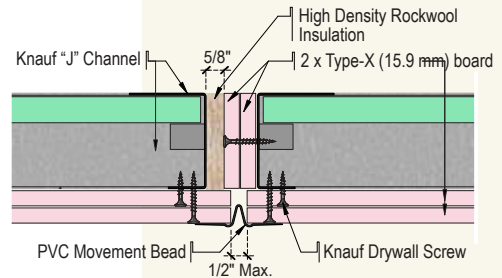

Training



Knauf Training academy has purposely been developed to offer a variety of courses that provide practical training on the design and construction of plasterboard systems.

Training also improves the safety on site and help companies complete projects more efficiently whilst taking advantage of learning Hands-on experience whilst under the guidance of a Knauf Training Specialist.

The courses that we offer include partitions, wall linings, shaftwalls and suspended ceilings. Training is also provided on tape & jointing (hand application).

The main aim of these courses is to provide knowledge and an understanding on the installation and the key purpose of Knauf drywall systems. Also we want to ensure that all trainees have full confidence in their ability when either proposing a Knauf system or constructing a system on-site. Knauf Training will also give you a better understanding of the products that we offer in the market, and allow you to understand what products are needed to assemble a Knauf system correctly and professionally. With the growing pressure & expectations of developers for fast and professionally constructed work, you can be sure with the knowledge & guidance of Knauf expert trainers you will be on the road to perfection.



The Key Advantages of Knauf Training:

- Improve efficiency
- Reduce wastage of materials
- Learn proper application methods
- Faster installation time
- Practice in the use of high-end drywall tools
- Ensure successful delivery of projects

Upon completion of any of the Knauf training courses a Knauf training attendance/recognition Certificate is awarded. This certificate gives you an edge over other competitors, as it is an endorsement that you have been instructed in the best practice of the industry, by the best in the industry. This in-turn gives us the confidence to then recommend you to future developers.

**Get your TRAINING RECOGNITION CERTIFICATE today and keep your company ahead of the competition
REMEMBER TO BE THE BEST YOU NEED TO LEARN FROM THE BEST**

Installation steps

- 1 After fixing the head track, the floor track should be positioned by using a vertical stud and a laser / spirit level.



- 2 Fixing Knauf 'C' Stud to form the position frame abutment.



- 3 Twisting Knauf 'C' Stud into position.



- 4 Snip and bend back Knauf 'U' Channel for extra rigidity around door



- 5 Insert timber battens within Knauf 'C' Studs to provide fixing for door frame (if required).



- 6 Snip and bend back Knauf Deep Flange 'U' Channel to form the door frame.



- 7 Fixing Knauf Deep Flange 'U' Channel to form perimeter framing



- 8 Fixing Knauf Plasterboard to the completed framework.



General requirements

Control joints

- At maximum 10m.
- At all control / expansion joints present in the structure.
- At any change in the substrate material.

Jointing

- Jointing should be done with joint compound Knauf Readygips and Knauf Joint Tape.
- On double layer partitions, jointing can be done only for the upper layer.

Connections sealing

- For acoustic requirements, seal the perimeter connections with acoustical sealant

Fire penetration

- Use approved fire penetration details and sealants.

- M&E cabling can be inserted through Knauf CW studs
- Insulation materials such as stone wool, glass wool, EPS should be planted within the CW studs.
- The insulation can be fixed either friction fit or fixed securely by other means.
- Once the insulation + cabling work is finished, the board on the other side of partition should be cladded

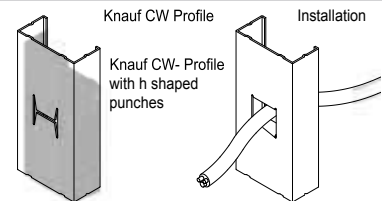

- Power sockets, switch sockets, splitter sockets etc. are allowed to be installed at any position.
- In systems with sound requirements, do not install power sockets opposite to each other
- Electrical socket boxes can be formed by using punching tools
- For fire rated systems, the socket must be fire rated with minimum the same fire rating as the partition.
- Use tested and certificated putty pads for sockets in fire rated systems.



Processing gypsum boards

Cut the paper face with a sharp knife



Score the board by pushing along the cut side, then cut the other paper side



Cut the board 45 degrees



Smooth the cut edge with a beveler



Cutting and processing the boards

- Knauf Boards shall be cut by scoring and breaking or by sawing
- When cutting by scoring, the face paper shall be cut with a utility knife
- Knauf boards shall be broken by snapping boards in the reverse direction, then cutting the back paper with a utility knife
- Cut edges should be smoothed with Knauf Beveler / Rasp Combo to obtain neat joints when installed
- Short edges should be chamfered with Knauf Beveler / Rasp Combo
- Holes for pipes or other small openings shall be scored on the back and the face outlined before removal / cut out with a purposely designed tool.

Studs positioning

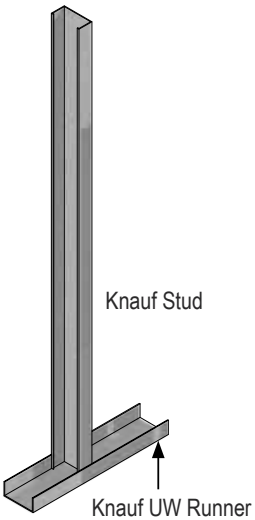
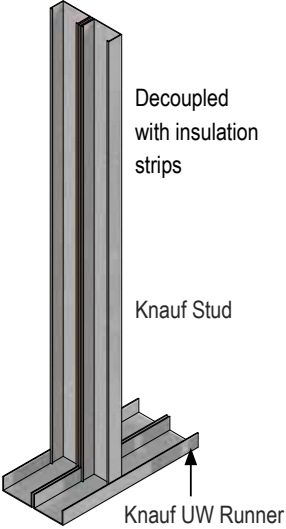
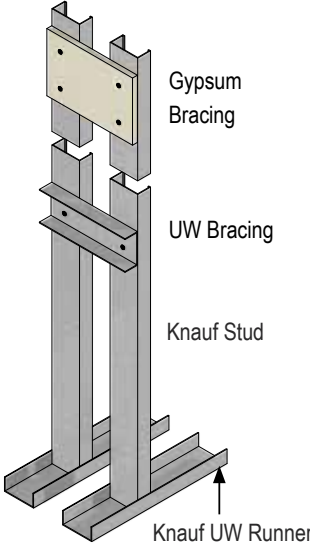
System KW A111 / A112	System KW A115	System KW A116
 <p>Knauf Stud</p> <p>Knauf UW Runner</p>	 <p>Decoupled with insulation strips</p> <p>Knauf Stud</p> <p>Knauf UW Runner</p>	 <p>Gypsum Bracing</p> <p>UW Bracing</p> <p>Knauf Stud</p> <p>Knauf UW Runner</p>

Positioning the tracks and perimeter studs

- Mark location of partitions accurately on concrete structure with stringline / laser
- Use Knauf Sealing Tape or Acoustical Sealant under Knauf CW studs and UW Tracks forming the perimeter for acoustic rated partitions use acoustical sealant or fire & acoustical sealant
- Bottom and top track shall be aligned accurately at the floor and ceiling
- Fix the bottom UW track and top track and CW studs on perimeter at maximum 610 mm centers for non fire rated partitions (at 500 mm center for fire rated partitions) and maximum 50 mm from end of track

Studs positioning - splicing of studs

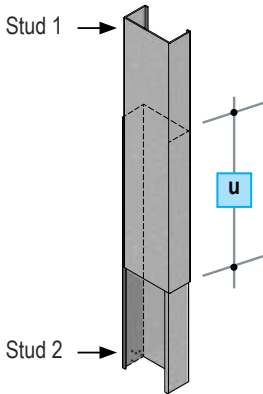
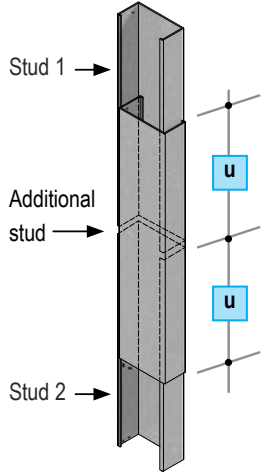
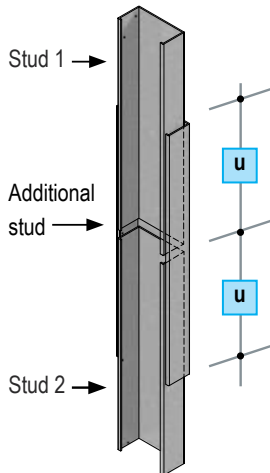
Option 1 – 2 CW studs interlaced like a box	Option 2 – 2 CW studs. Joint connected with additional CW stud	Option 3 – 2 CW studs. Joint connected with additional UW track
 <p>Stud 1</p> <p>Stud 2</p> <p>u</p>	 <p>Stud 1</p> <p>Additional stud</p> <p>Stud 2</p> <p>u</p> <p>u</p>	 <p>Stud 1</p> <p>Additional stud</p> <p>Stud 2</p> <p>u</p> <p>u</p>



Vertical extension of studs (splicing)

Stud size	Overlap u
CW 41	≥ 41 cm
CW 64	≥ 64 cm
CW 89	≥ 89 cm
CW 102	≥ 102 cm
CW 152	≥ 152 cm

Calculation example:

- Option 1 CW 64 – overlap 64 cm
- Option 2 CW 64 – additional piece CW 64, 128 cm
- Option 3 CW 64 – additional piece of UW 64, 128 cm

- Displace stud joints vertically
- In the overlap area, rivet, screw attach or crimp the studs

Framing

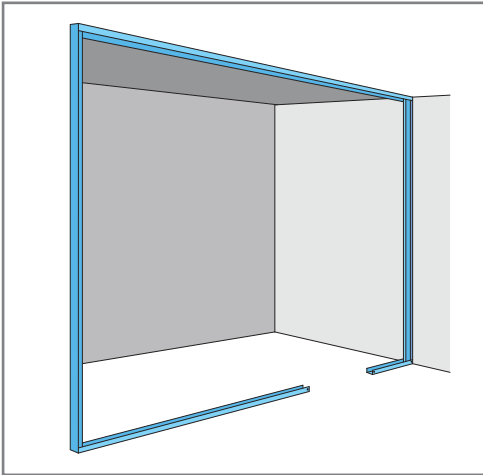

Framing

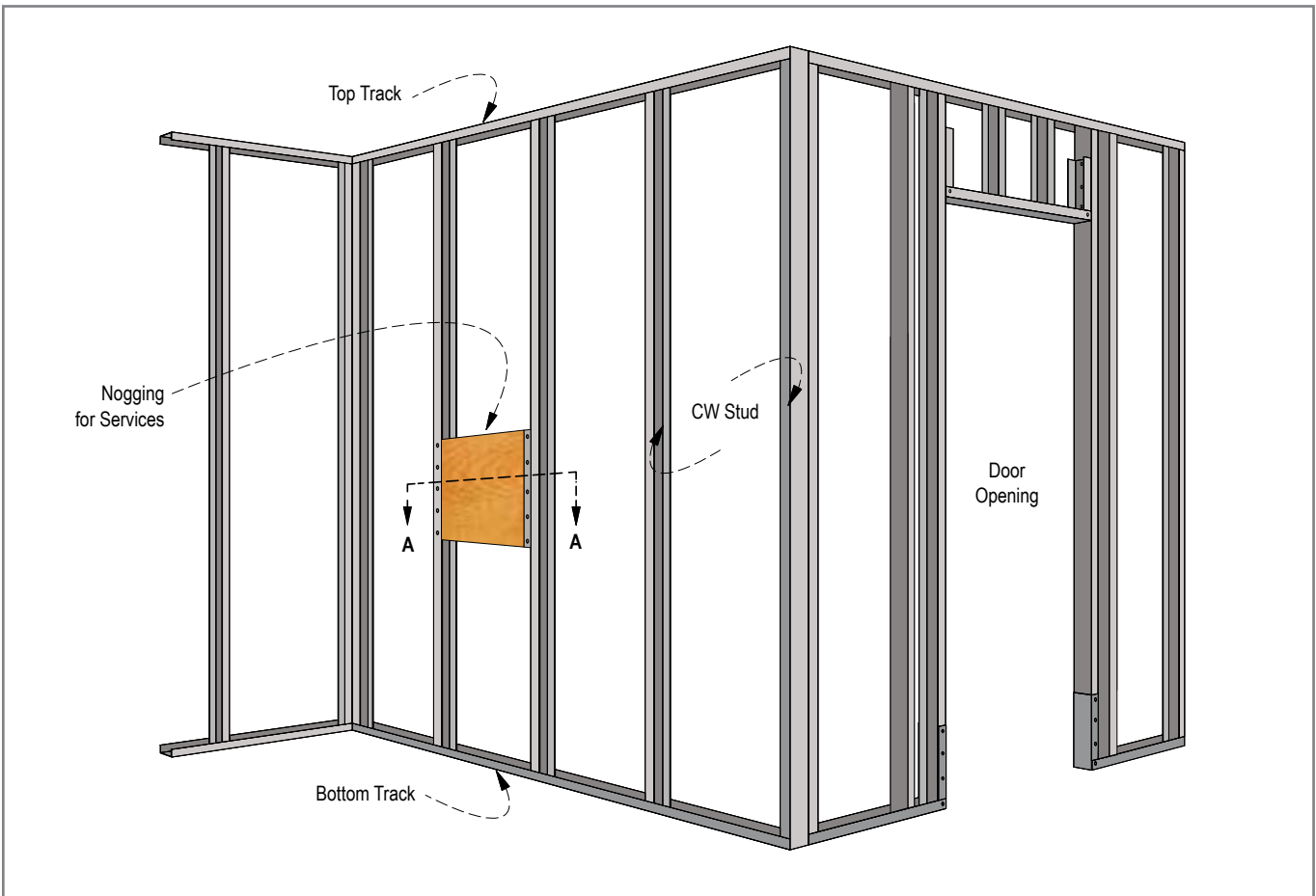

- Knauf partition standard deflection detail allows for 10 mm positive / negative deflection
- For higher deflection, use the deflection head
- Space studs at max. 610 mm centers. For partitions where loads are going to be applied, please follow our details for nogging
- Friction fit Knauf CW Studs vertically into Knauf UW Tracks with maximum spacing of 610 mm, this will allow for adjustment when boarding
- Extra studs should be provided at openings, corners and stop ends. Studs at corners, stop ends, T junctions and openings should be fixed to floor and ceiling channels by metal framing screws or pierce punching

Fixing loads / Cantilever loads

Nogging for Services

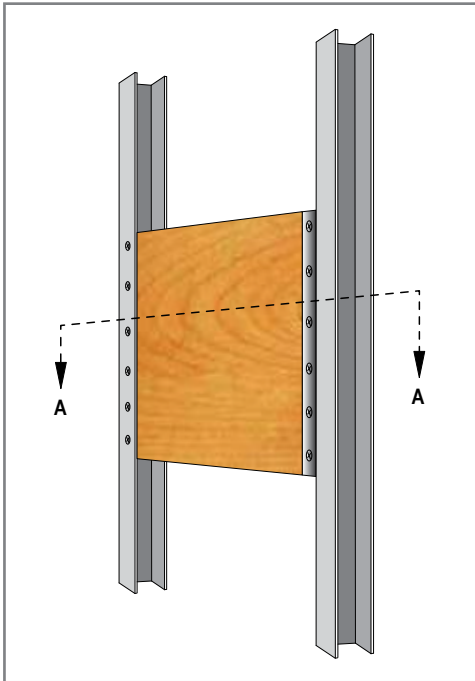

- Install a 18 mm plywood backing between the profiles
- Fix the plywood on one side with L angle (25 x 25 x 0.5 mm)
- Screw spacing: 100 mm
- The plywood backing should be 100 mm wider than total height of the object (wash basin, cupboard)

Section A - A

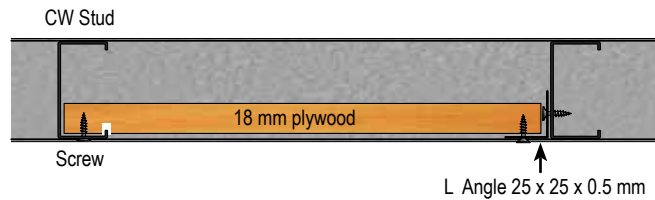

Crowd pressure and loading capacity heavyweight anchorage

Min. Stud Size	Cladding Thickness	Performance Achieved		
		Crowd Pressure	Heavyweight Anchorage - wash basin	Heavyweight Anchorage - wash cupboard
CW 64 x 33 x 0.5 mm	1 x 12.7 mm	1.5 kN/m	1500 N*	2000 N*
CW 64 x 33 x 0.5 mm	2 x 12.7 mm	3.0 kN/m	2500 N*	5000 N*

* K543 Knauf Hartmut with M5 x 60 mm screw with additional 18 mm thick plywood backing

** K543 Knauf Hartmut with M5 x 75 mm screw with additional 18 mm thick plywood backing

Loading capacity lightweight anchorage

Cladding Thickness	Driva Plus Self Drilling Metal Plug	Cavity Fixings	Knauf Hartmut
min. 12.7 mm	7 kg	12 Kg	35 Kg
min. 2 x 12.7 mm	> 7 Kg	> 12 Kg	55 Kg

Door openings

- Use Boxed Knauf CW Studs for forming door frames (up to 60 kg)
- Locate a vertical stud within 76 mm of door frame for reinforcement
- UW Channel used for floor track should be extended min 300 mm and returned and fixed to the CW door stud
- Additional fixings should be included when fixing the floor channel, 150 mm back from the opening

Doors Framing

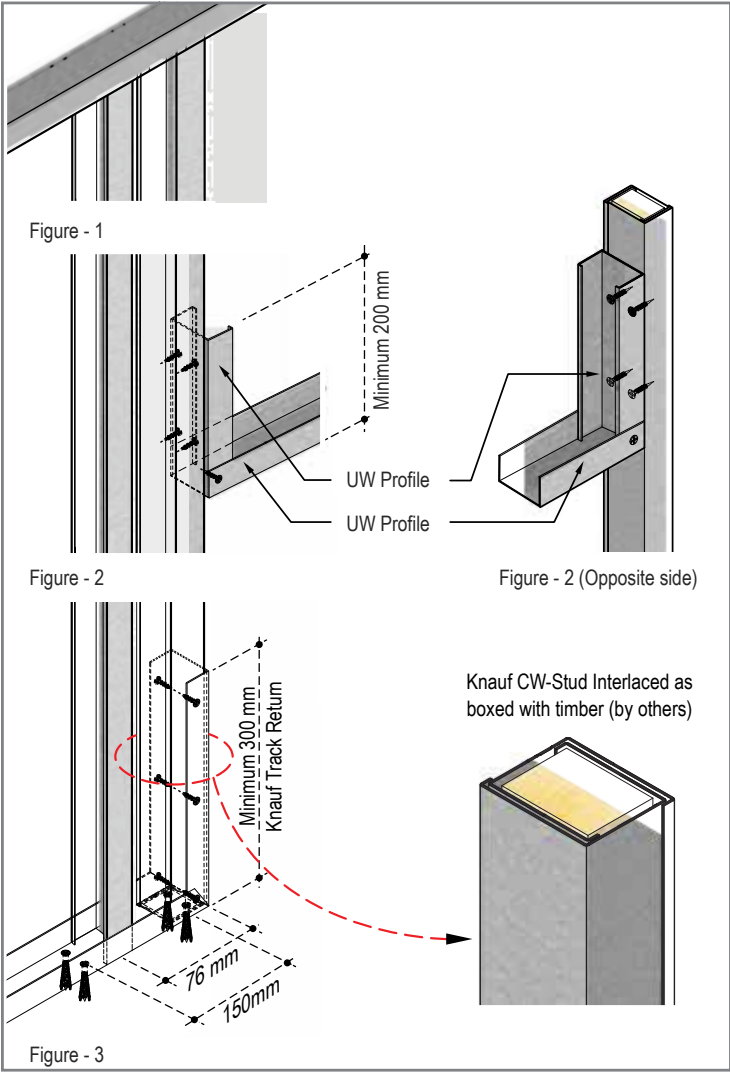
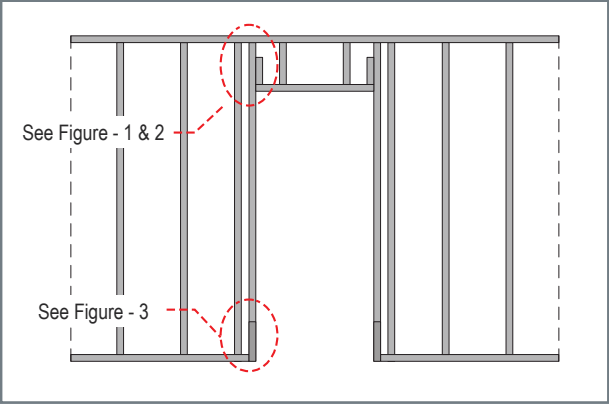

- A head shall be formed over metal door with a cut-to-length section of track
- The section of track shall then be placed horizontally at the relevant height with flanges
- Cut and web bent vertically at each end, then securely attached to the vertical studs
- A cut-to-length section of stud shall then be positioned vertically above the door head and extending to the ceiling track

Doors Framing / Door opening with CW studs

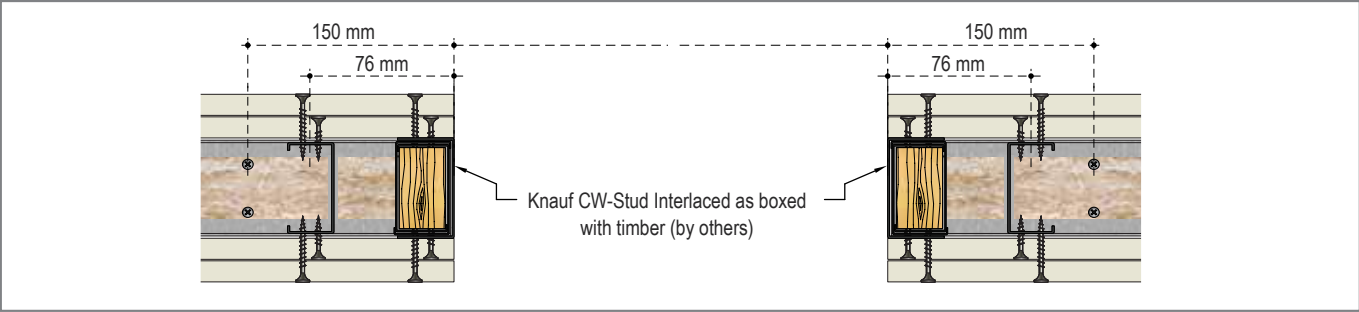

Door weight	No. of layers on each side	Profile	Load class
Up to 60 kg	2 + 2	Min. CW 64 x 33 x 0.5 mm	Severe duty 100 slams
Up to 100 kg	2 + 2	Min. CW 64 x 33 x 0.5 mm	Minimum duty 20 slams



Window openings

Window Opening Frame

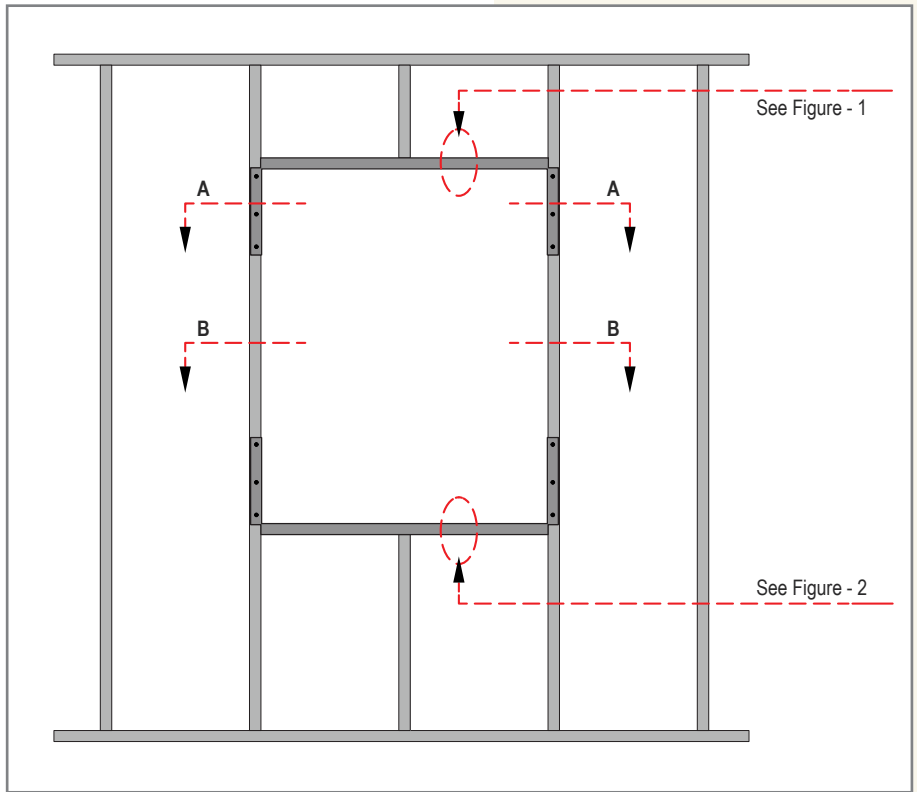
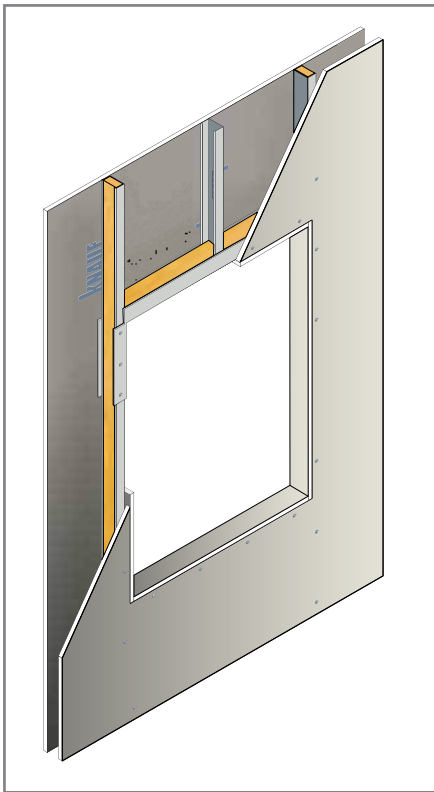
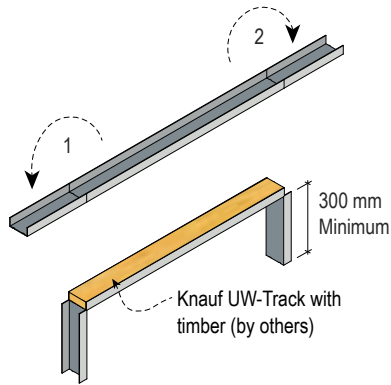
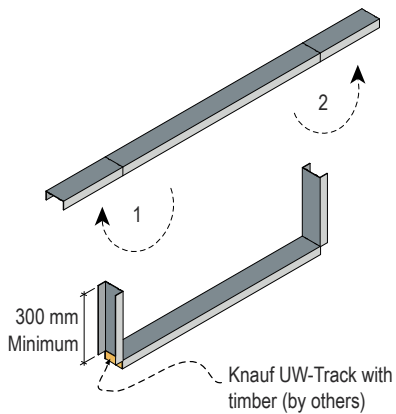

Figure - 1
U-Channel



- CW Studs should be reinforced with timber (by others).
- UW tracks should be snipped and bent and reinforced with timber for extra rigidity.
- Cladding of the boards should follow the partition requirement (one layer / two layers .etc).

Figure - 2
U-Channel



Door opening with U-Channel & CW-Studs

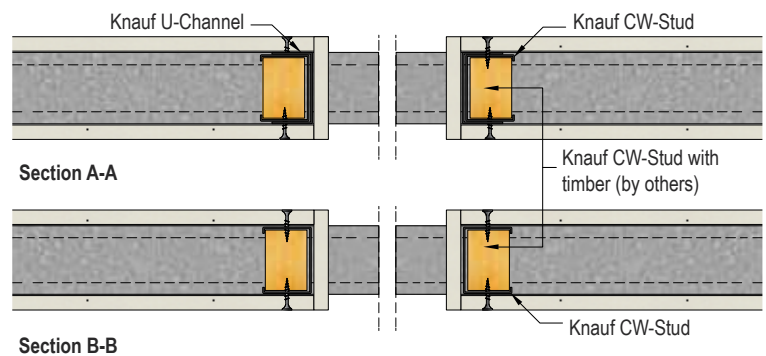

Cladding of boards

First Layer Cladding

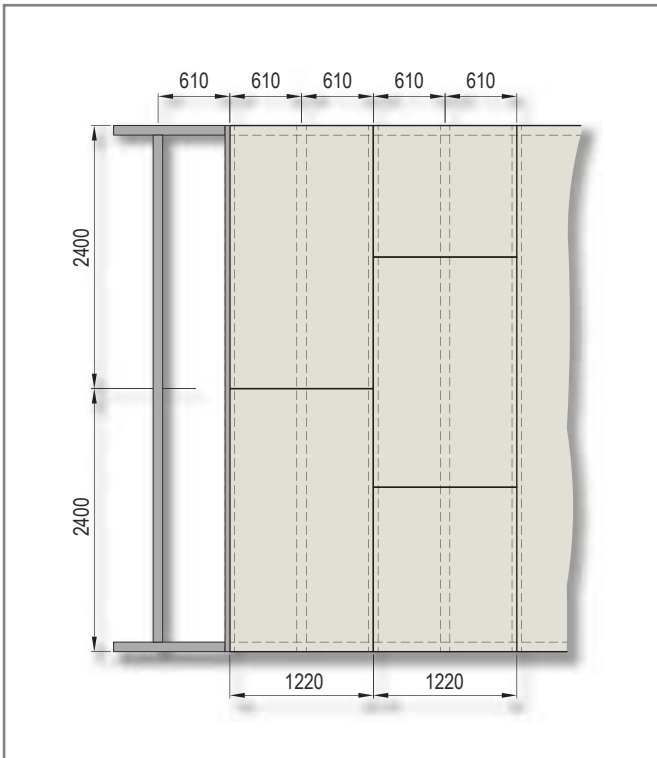

Second Layer Cladding

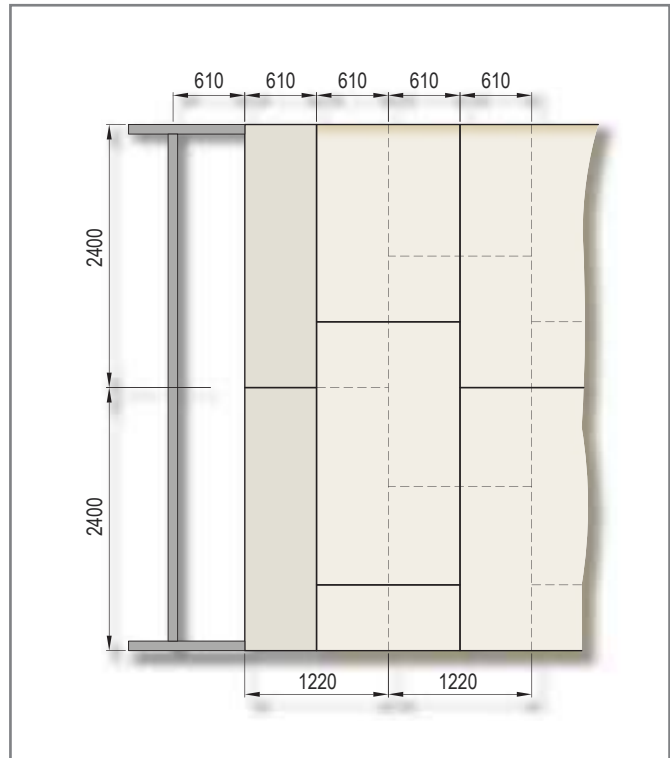

Fixing

- Knauf Board should be fixed vertically on the metal stud framework
- Boards should never touch the floor. Approximately 10 mm of gap should be left at the floor connection when fixing boards
- The gap should be filled with sealant or mastic
- Vertical edges should be staggered by 600mm. Horizontal edges should be staggered by at least 305 mm.
Both joints (horizontal and vertical) on opposite side of partition should be staggered
- For multi-layer cladding, second layer should be staggered both horizontally and vertically

Connections sealing

- For acoustic requirements in non fire rated partitions, seal the perimeter connections with acoustical sealant
- For acoustic and / or fire requirements in fire rated partitions, seal the perimeter connections with fire and acoustical sealant

Boards fixing

Screw location and penetration depth

- Drive screws to just below the sheet surface, taking care not to break the paper linerboard.
- Screw heads must be approx. 1 mm inside the board surface
- Screws should be 9.5 mm away from joints
- Screws should penetrate studs by min. 9 mm

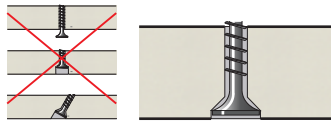
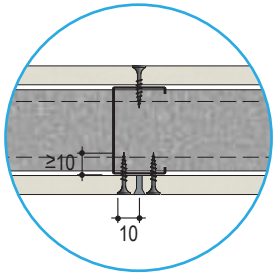

Correct screw head position

Fastening of the cladding

Board thickness	First Layer	Second Layer
12.7 mm	TN 3.9 x 25 mm	TN 3.9 x 35 mm
15.9 mm	TN 3.9 x 25 mm	TN 3.9 x 45 mm

Maximum screw spacing – framing at 610 mm center to center

Number of Layers	First Layer	Second Layer
First Layer	305 mm	-
Second Layer	305 mm	305 mm

Doors opening frame and cladding of boards

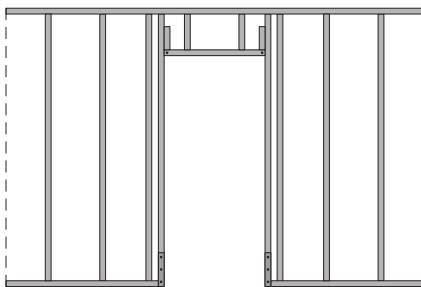

Door Opening Frame

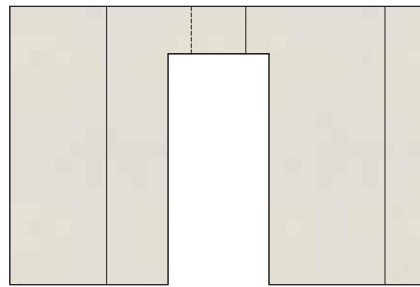

Cladding of Partition side 1

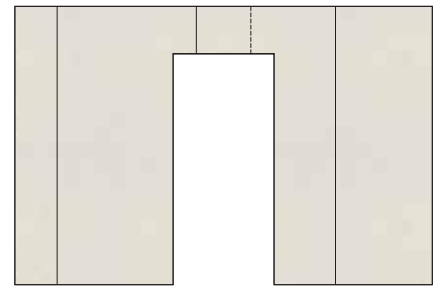

Cladding of Partition side 2

- Do not apply board joints on door frame profiles
- Joints should be staggered on both sides

Curved partitions

Bending radius - Knauf boards

Board thickness d mm	Bend radius r in longitudinal direction	
	Dry bending mm	Wet bending mm
6.4 mm	1500 mm	≥ 1000 mm
7.8 mm	2500 mm	≥ 2000 mm

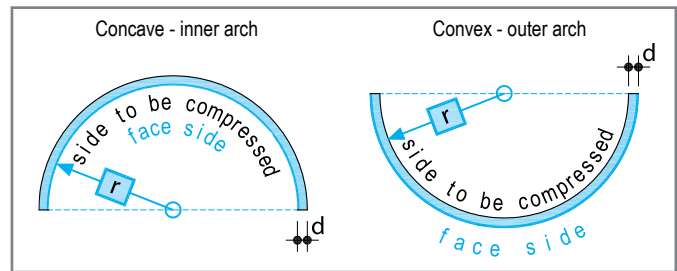

- Other Knauf boards / bending radius on request

Curved partitions

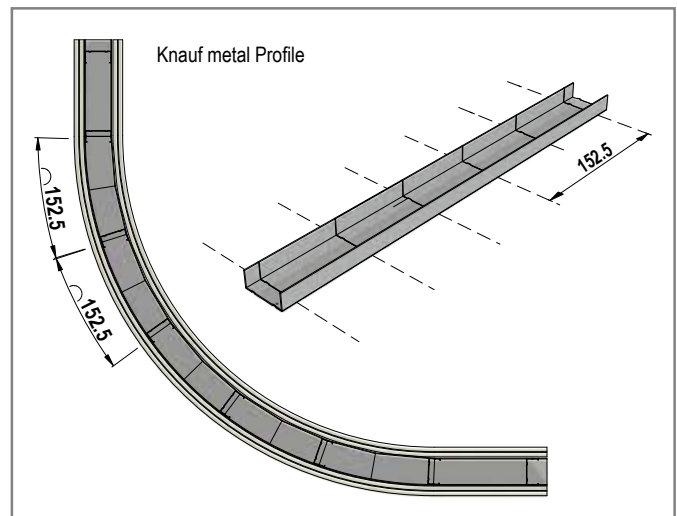
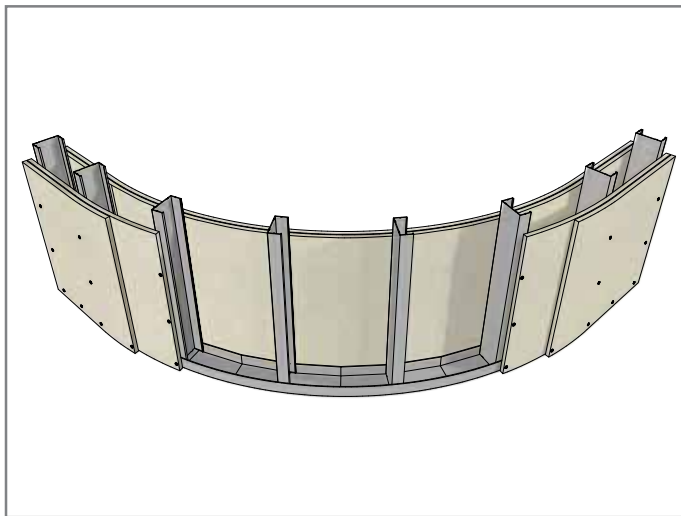

Knauf UW track cut and bent

- Connect the CW Stud with Knauf metal profile using a crimp connection
- CW Stud spacing: 152.5 mm (external radius)
- Knauf fastener spacing: ≤ 305 mm

Wet bending

- Put the cut-to-length Knauf boards on a grid made of channels or similar with the side to be compressed on top (to ensure that excess water can drip off)
- Perforate the board laterally and longitudinally with a spiked roller
- Wet the board by spraying or use a lambskin roller and allow it to settle for a few minutes. Repeat the process until saturation is achieved and allow the excessive water to drain
- Place the board on the prepared template, bend and fix the board with adhesive tape and allow to dry

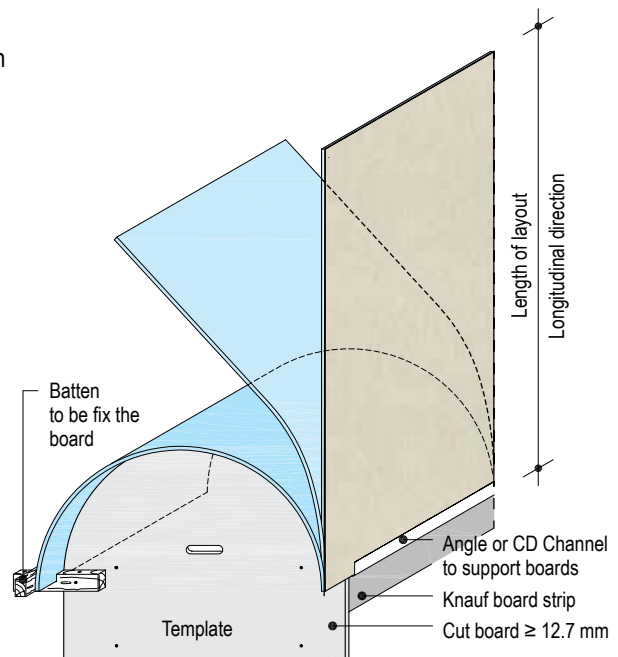

Dry bending

- Slowly bend the Knauf board laterally over the stud partition. Pre-bending on a template is recommended
- Fix with Drywall Screws continuously following the bending direction

Joint treatment

- Board surface should be cleaned of materials such as dust, oil etc.
- Filling and covering of joints should only take place after the boards have been allowed to rest in the given humidity and temperature zones, and no more longitudinal changes can be expected, i.e. expansion or contraction.
- In case of mastic asphalt screed, fill in joints after screed has been applied.
- First coat of Knauf Joint filler should be applied with tools of sufficient width to extend a minimum 50 mm beyond both sides of the centre of the joint (100 mm width).
- Knauf Joint Tape should be embedded into the joint filler to reinforce the joint between two gypsum boards
- Once the first coat has dried, a second coat of Knauf Joint filler should be applied with 100 mm width on both sides of the centre of the joint tape (200 mm width).
- A very thin third coat of Knauf Joint filler should be applied with a minimum width no less than 150 mm beyond both sides of the centre of the joint tape (300 mm width).
- Once third coat has dried, surface should be sanded and smoothed
- Knauf Corner Bead should be used for exterior corner reinforcements
- Alternatively Knauf Alux Corner Tape can be used to reinforce interior or exterior corners

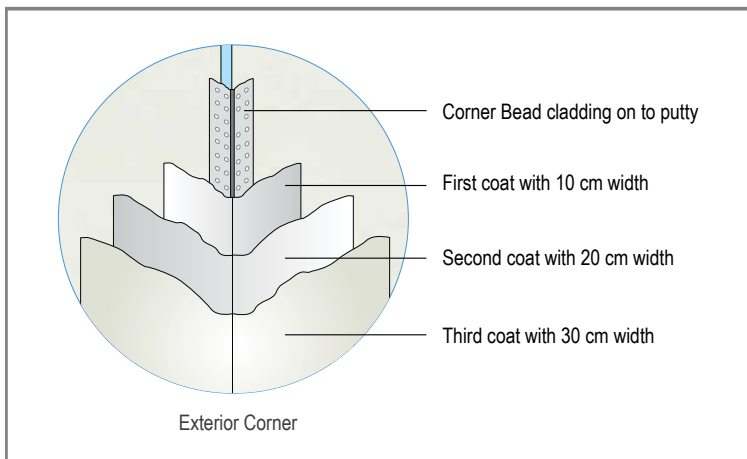

Pre-Treatment

Before further linings (wallpaper) are applied, the surface must be free of dust and pretreated according to lining manufacturer.

Suitable coatings and linings

- Wallpaper (paper, non woven, textile and synthetic wallpapers)
- Ceramic tiles*, plasters (full surface thin plaster coatings)
- Coatings (emulsion based paints, emulsion based silicate paints)

Unsuitable coatings

Alkaline coats such as lime based paints, silicate based paint and pure silicate paints are not suitable to be applied on gypsum boards. Gypsum board paper surfaces that have constantly been exposed to light without any protection can develop yellowing agents that show up despite a coat of paint. Therefore, a trial coat is recommended that will extend across several boards including all joints. Yellowing can, however, be successfully avoided only by using a special shielding primer.

BOARDS

GYPSUM BOARDS

Knauf Gypsum Wall Board (GW-R)

Knauf Regular Gypsum Boards are ASTM C1396 compliant gypsum Backing Boards, specifically designed for use where high quality Gypsum Board requirements are essential to achieve the desired interior design intent.

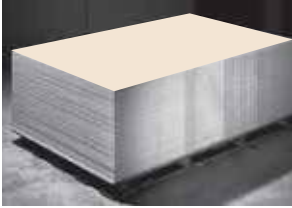

Boards Dimensions

Thickness: 12.7 / 15.9 mm
Width: 1220 mm
Length: 2400 or 3000 mm

* Special sizes are available upon request.

Board Weight (average values):

12.7 mm approx. 9.7 kg / m²
15.9 mm approx. 12.3 kg / m²

Average Water Absorption: N/A

Nail Pull Resistance: ASTM C473 : 2010 Clause 13

12.7 mm ≥ 343 N
15.9 mm ≥ 387 N

Edge Detail

Square Edge (SE) 

Taper Edge (TE) 

Appearance: Ivory Paper Liner

Standard and Codes:

ASTM C1396 / C1396M - 14a Sec.5
ASTM E84 - Flame Spread = Class 1 or A
Intertek listed under CSI Code 09 29 00

Flexural Strength: ASTM C473 : 2010 Clause 11

Thickness 12.7 mm 15.9 mm
Parallel ≥ 160 N ≥ 205 N
Perpendicular ≥ 476 N ≥ 654 N

Knauf Moisture Resistant Gypsum Backing Board (GB-WR)

Knauf Moisture Resistant Gypsum Boards are ASTM C1396 compliant gypsum Backing Boards, specifically designed for use in areas with humidity and exposure to moisture.

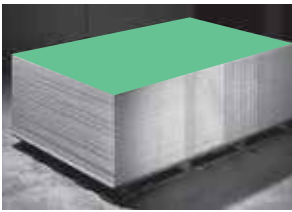

Boards Dimensions

Thickness: 12.7 / 15.9 mm
Width: 1220 mm
Length: 2400 or 3000 mm

Board Weight (average values):

12.7 mm approx. 9.7 kg / m²
15.9 mm approx. 12.3 kg / m²

Average Water Absorption: ≤ 5%

Nail Pull Resistance: ASTM C473 : 2010 Clause 13

12.7 mm ≥ 343 N
15.9 mm ≥ 387 N

Edge Detail

Square Edge (SE) 

Taper Edge (TE) 

Appearance: Green Paper Liner

Standard and Codes:

ASTM C1396 / C1396M - 14a Sec.7
ASTM E84 - Flame Spread = Class 1 or A
Intertek listed under CSI Code 09 29 00

Flexural Strength: ASTM C473 : 2010 Clause 11

Thickness 12.7 mm 15.9 mm
Parallel ≥ 160 N ≥ 205 N
Perpendicular ≥ 476 N ≥ 654 N

Knauf Type X Fire Rated Gypsum Wall Board (GW-TX)

Knauf Fire Resistant Gypsum Boards have been evaluated to meet the requirement of a TYPE X (Special Fire - Resistant) compliant board as defined by ASTM C 1396. These boards are specifically designed for use in areas where high fire protection is required.

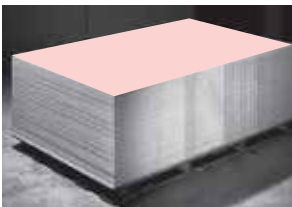

Boards Dimensions

Thickness: 12.7 / 15.9 mm
Width: 1220 mm
Length: 2400 or 3000 mm

Board Weight (average values):

12.7 mm approx. 10.5 kg / m²
15.9 mm approx. 13.1 kg / m²

Total Water Absorption: ≤ 5%

Nail Pull Resistance: ASTM C473 : 2010 Clause 13

12.7 mm ≥ 343 N
15.9 mm ≥ 387 N

Edge Detail

Square Edge (SE) 

Taper Edge (TE) 

Appearance: Pink Paper Liner

Standard and Codes:

ASTM C1396 / C1396M - 14a & Type-X
ASTM E84 - Flame Spread = Class 1 or A
Intertek listed under CSI Code 09 29 00

Flexural Strength: ASTM C473 : 2010 Clause 11

Thickness 12.7 mm 15.9 mm
Parallel ≥ 160 N ≥ 205 N
Perpendicular ≥ 476 N ≥ 654 N



Certified by: Intertek



GYPSUM BOARDS

Knauf Type X Moisture Resistant Gypsum Backing Board with Fire Rated Properties (GB-WRTX)

Knauf Fire and Moisture Resistant Gypsum Boards have been evaluated to meet the requirement of a Type X (Special Fire-Resistant) compliant board as defined by ASTM C1396. These boards are specifically designed for use in areas where high fire and moisture protection is required.

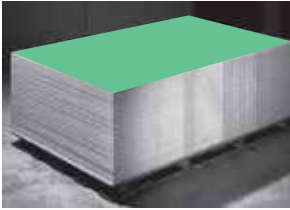

Boards Dimensions

Thickness: 12.7 / 15.9 mm
 Width: 1220 mm
 Length: 2400 or 3000 mm

Board Weight (average values):

12.7 mm approx. 10.5 kg / m²
 15.9 mm approx. 13.1 kg / m²

Average Water Absorption: ≤ 5%

Nail Pull Resistance: ASTM C473 : 2010 Clause 13

12.7 mm ≥ 343 N
 15.9 mm ≥ 387 N

Edge Detail

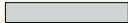
Square Edge (SE) 

Taper Edge (TE) 

Appearance: Green Paper Liner

Standard and Codes:

ASTM C1396 / C1396M - 14a Sec.5
 ASTM E84 - Flame Spread = Class 1 or A
 Intertek listed under CSI Code 09 29 00

Flexural Strength: ASTM C473 : 2010 Clause 11

Thickness 12.7 mm 15.9 mm
 Parallel ≥ 160 N ≥ 205 N
 Perpendicular ≥ 476 N ≥ 654 N

Knauf Type X Mold and Moisture Resistant Gypsum Backing Board

The Knauf Mold & Moisture resistant Gypsum Board is designed for use in interior wall and ceiling applications that are likely to be exposed to high moisture and humidity conditions. When compared to standard Knauf paper-faced gypsum board, this board offers enhanced protection against mold and moisture exposure that can cause deterioration and/or stains. It contains a non-combustible core and when tested in accordance with (ASTM D3273 - Resistance to Growth of Mold on the Surface of Interior Coatings in an Environmental Chamber) the board achieved the t score of 10 out of 10.

Product is available as 1/2"(12.7 mm) and 5/8"(15.9 mm) Type X (as defined in ASTM C1396).

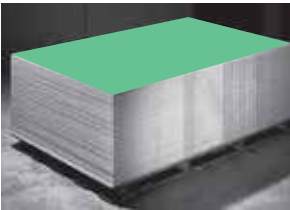

Boards Dimensions

Thickness: 12.7 / 15.9 mm
 Width: 1220 mm
 Length: 2400 or 3000 mm

Board Weight (average values):

12.7 mm approx. 9.7 kg / m²
 15.9 mm approx. 12.3 kg / m²

Average Water Absorption: ≤ 5%

Nail Pull Resistance: ASTM C473 : 2010 Clause 13

12.7 mm ≥ 343 N
 15.9 mm ≥ 387 N

Edge Detail

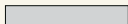
Square Edge (SE) 

Taper Edge (TE) 

Appearance: Green Paper Liner

Standard and Codes:

ASTM C1396 / C1396M - 14a Sec.7
 ASTM E84 - Flame Spread = Class 1 or A
 Intertek listed under CSI Code 09 29 00

Flexural Strength: ASTM C473 : 2010 Clause 11

Thickness 12.7 mm 15.9 mm
 Parallel ≥ 160 N ≥ 205 N
 Perpendicular ≥ 476 N ≥ 654 N

Knauf Type X Coreboard

Knauf Type X Core Board is designed to be used in conjunction with the Knauf Shaftwall systems. It has both fire and moisture resistant qualities.

A special 25mm thick, 609mm wide fire and moisture resistant board for use in the Knauf Shaftwall system. Shaftwall enables these boards to be fixed from one side only in minimal access situations. This board complies with ASTM C1396 and the Type X (special fire resistant) requirements.



Boards Dimensions

Thickness: 25.4 mm
 Width: 610 mm
 Length: 2400 or 3000 mm

Board Weight (average values):

25.4 mm approx. 20.4 kg / m²

Average Water Absorption: ≤ 5%

Edge Detail

Square Edge (SE) 

Appearance: Green Paper Liner

Standard and Codes:

ASTM C1396 / C1396M - 14a Sec.7 & Type-X
 ASTM E84 - Flame Spread = Class 1 or A
 Intertek listed under CSI Code 09 29 00



Certified by: Intertek

PROFILES

Knauf CW studs, ASTM C 645

Galvanized lightweight steel sections, to be used with non load bearing partition systems, zinc coating Z140. Galvanization Z180 available on request.

Standard length 3.00 m. Customized lengths upon request, subject to terms and conditions.

Stud size	Flange	Thickness	
CW 1 5/8" (CW 41 mm)	33 mm	25 GA 0.5 mm thick	20 GA 0.9 mm thick
CW 2 1/2" (CW 64 mm)			
CW 3 1/2" (CW 89 mm)			
CW 4 1/32" (CW 102 mm)			
CW 5 63/64" (CW 152 mm)			
CT 2 1/2" (CT 64 mm)	38 mm	20 GA 0.9 mm thick	
CT 4 1/32" (CT 102 mm)			
CT 5 62/64" (CT 152 mm)			

Knauf UW tracks, ASTM C 645

Galvanized lightweight steel sections, to be used as standard head and floor track for partition systems, zinc coating Z140. Galvanization Z180 available on request.

Standard length 3.00 m.

Track size	Flange	Thickness	
UW 1 5/8" (UW 41 mm)	25 mm & 60 mm	25 GA 0.5 mm thick	20 GA 0.9 mm thick
UW 2 1/2" (UW 64 mm)			
UW 3 1/2" (UW 89 mm)			
UW 4 1/32" (UW 102 mm)			
UW 5 63/64" (UW 152 mm)			
JT 2 1/2" (JT 64 mm)	25 mm & 51 mm	20 GA 0.9 mm thick	
JT 4 1/32" (JT 102 mm)			
JT 5 62/64" (JT 152 mm)			

Components and accessories

Knauf TN Drywall Screws

Black phosphated self drilling and self tapping screw with countersunk Philips heads for fixing gypsum board to metal framing. Ideal for use with light gauge metal up to 0.7 mm thick.



Cavity Fixings

Cavity fixing is used for superior loads on partitions and its design enables that the fixtures can be removed and refitted.



TB Self-Tapping Screw

Self drilling screws with countersunk Philips heads for fixing gypsum board on metal grids up to steel thickness 0.7 mm and 2.0 mm.



Wedge Anchor

Wedge Anchor is a very easy-to-apply accessory which can be used as an alternative solution to Plastic Plug & Screw in terms of fire rated partitions.



Knauf Plastic Plug and Screw

Knauf Plastic Screw is to be used together with Plastic Plug for fixing perimeter tracks and studs on solid walls.



Knauf Hartmut

The most advanced cavity dowel for drywall systems with a load capacity of up to 65kg.

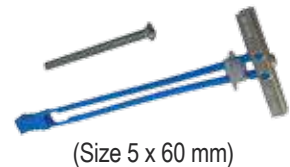

Hammer Fixing

Hammer Fixings are light duty fixings which have a special thread lock design that prevents pre-expansion during transit installation and provides an option for faster fixing without screwdriver work. Both sizes are suitable for perimeter fixings for both partitions and ceilings. In addition to that, 8 x 45 mm is perfectly suitable with universal bracket in wall claddings. Hammer fixings are faster alternatives to the Plastic plug and Plastic plug screw.



Concrete Screwbolt

Concrete Screwbolt is a non-expansion bolt with undercut technology for fixing into wood, brick, cracked or non-cracked concrete and it is a high performance bolt that cuts its own thread. It suits perimeter fixings, to some details of Fire Resistant partition and is specific for Head of Wall connections.



COMPONENTS AND ACCESSORIES

Knauf LN Waferhead Screws

Zinc coated self drilling tips with low profile head for metal to metal fixing. Suitable for use with light gauge up to 1.4 mm thick



Driva Plus Self Drilling Metal Plug

Driva Plus with screw requires no drilling and can be screwed simply on the partitions for standard loads.



Knauf Acoustical Sealant

Knauf Acoustical sealant is a pasty dispersion bound compound for sealing perimeters and under tracks in acoustic rated partition systems.



Knauf Alux Corner Tape

Knauf Alux Corner Tape is a flexible paper tape roll with metal strip reinforcements. The tape is bent inwards or outwards from the middle and is applied to interior or exterior corners to reinforce the edges of drywall application such as partitions, ceilings, walling.



Knauf "FiAM" Fire Resistant Sealant

Knauf "FiAM" Fire Resistant Sealant is a one part water based acrylic emulsion that can provide up to 5 hours fire resistance when used in construction joints and services in both vertical and horizontal applications



Knauf Sealing Tape

Recommended for use within the Knauf W115 wall system as a sound isolator. Tape is placed on the flange of the CW Studs, only to one side of the wall system



Knauf Special Textile Fiber Glass Joint Tape

Special Textile Fiber Glass Joint Tape is a premium joint tape which performs at the best level to prevent cracks and to provide the best finishing.



PVC control Joint (Movement Bead)

Designed to provide for movement to accommodate expansion and contraction caused by initial stucco shrinkage and minor thermal movement.



Knauf Kurt Paper Joint Tape

Paper joint tape used for reinforcing joints by hand application, it is recommended to ensure crack free joints on drywall systems.



PVC Shadowline Trim

PVC Shadowing trim is preferred especially for aesthetic drywall finishing and it is used to create a shadow line which minimizes building imperfections.



Knauf Joint Tape

Fiber Glass Joint Tape for board joint reinforcement. Width 50 mm. Length 90 m



Edge Bead Micro

Edge finishing and protection for gypsum boards with fine expanded metal wings provides superior keying to the plasters, which eliminates shadowing and avoids cracking.



Knauf Readygips Joint filler

Readymixed compound for joint filling. Bucket, 28 kg. Buckets Per Pallet : 33



Corner Bead Micro

Corner finishing and protection for gypsum boards with fine expanded metal wings provides superior keying to the plasters, which eliminates shadowing and avoiding cracking.



Knauf EASY - Finish

EASY - Finish is designed for internal use only and is intended to provide a perfectly smooth and level surface ready for the final decoration or wall finishing.



Knauf Angle Sections

Galvanized lightweight steel sections for use as hanger support for ceilings and reinforcement for deflection head details in partition systems.

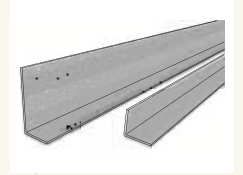

COMPANY'S CERTIFICATION

Estidama and LEED compliant products

As per Estidama & LEED requirements, our products have been tested for chemical materials banned or required to be in a very low concentration in third party well known laboratories.

Asbestos

Our products are free from asbestos. Boards produced in Knauf factory in Ras al Khaimah have been tested for asbestos content, no asbestos was detected. Complies with international requirements regulating this substance.

Formaldehyde

The boards produced in Knauf factory in Ras al Khaimah have been tested on DIN EN ISO 16009 for formaldehyde emissions. Maximum recorded concentration levels on 30 days testing were $16\mu\text{g} / \text{m}^3$ ($0.016 \text{ mg}/\text{m}^3$) – below the limits required in international standards.

VOC

Knauf joint compound Readygips has been tested for VOC (volatile organic compounds). Detected amount: 0.14 g/l is below the limits required in international standards.

Regional materials

On a range of 500 miles from factory and quarry location, our boards can provide points for regional materials mentioned in different evaluation criteria (LEED, Estidama, etc.)

ISO certifications

Knauf factory from Ras al Khaimah is holding ISO 9001:2008 Quality Management System certification since 2011. Knauf has been certified on ISO 14001: 2004 and BHS OHSAS 18001:2007

Environmental certifications

For outstanding performances in water and energy management, our factory has been awarded the Environmental Performance Certificate from the Ministry of Environment and Water.



Civil Defense Approval

Knauf has Civil Defense Approval from RAK Civil Defense and Qatar Civil Defense for factory and systems. Our fire rated systems are not only certified with accredited international bodies, but also recognized by local authorities

رقم الترخيص: K121
سنة الترخيص: 2017
عدد الترخيص: (5 - 1)

رقم الترخيص	اسم الشركة	اسم المنتج	رقم شهادة المنتج	اسم الشركة	اسم المنتج	رقم شهادة المنتج
2017/06/08	Intertek USA	Model: Knauf GW-FX, Non-Loadbearing Head of Wall Jailer Made of Four (2 1/2 inch) Wide Pieces of 15.9 mm Thick GW-FX, Min. Thickness: 43.5 mm, Fire Rating: 2 Hr, Usage: Interior, as per Design Listing Reference K1.G.RF 120-01.	WH1118 - 2282401	KNAUF	الواح جبس مقاومة للحريق Fire Resistant Gypsum Board	2017/06/08
2017/06/16	Intertek USA	Model: Knauf GW-FX and 100-01 19 wall system, Non-Loadbearing Double Layer Shaft Wall with Deflection Head Assembly Min. Wall Thickness: 97 mm, Resistance Period: 2 Hr, Usage: Interior, as per Design Listing Reference K1.G.RF 120-02.	WH0115 - 2282402	KNAUF	الواح جبس للتكسية مقاومة للحريق Fire Resistant Gypsum Board	2017/06/16
2017/06/08	Intertek USA	Model: Knauf GW-FX and 011-01, Non-Loadbearing Head of Wall Jailer Made of Four (2 1/2 inch) Wide Pieces of 15.9 mm Thick GW-FX, Min. Thickness: 43.5 mm, Resistance Period: 1 Hr, Usage: Interior, as per Design Listing Reference K1.G.RF 120-03.	WH1117 - 2282403	KNAUF	الواح جبس للتكسية مقاومة للحريق Fire Resistant Gypsum Board	2017/06/08
2017/06/16	Intertek USA	Model: Knauf 15 FH W112 Wall System, Non-Loadbearing Drywall Partition Made of 2 Layers of 13 mm of (FH), Min. Wall Thickness: 110 mm, Usage: 120 Min. Resistance: 120 Min, Usage: Interior Drywall Partition, as per Design Listing Reference K1.G.RF 120-07.	WH0115 - 22825414	KNAUF	الواح جبس مقاومة للحريق Fire Resistant Gypsum Board	2017/06/16

ملاحظة: ان تكون دولة الإمارات العربية المتحدة من أفضل دول العالم أمنا وسلاما

Certified products

Knauf Factory in RAS al Khaimah is certified for production of Type X boards, regular gypsum boards, Readygips and its profiles by Intertek USA.

Knauf Boards are bearing the prestigious Warnock Hersey Mark that is a guarantee for product compliance to ASTM C 1396 and Type X certification for fire rated boards.

The Warnock Hersey Mark (WH) is North America's leading product safety and performance mark for building and construction products.

Products bearing the WH Mark indicate compliance to relevant building codes, association criteria, and product safety and performance standards. Intertek's Warnock Hersey (WH) Mark has long been the building product industry's preferred certification mark. The WH Mark can be found on more than 6,500 products ranging from fire doors and builders' hardware to hearth, plumbing and construction products. Having Intertek's WH Mark on product reflects our commitment to product safety, performance and quality to inspectors, builders and end users.

The mark also signifies that the product's manufacturing site undergo periodic follow-up inspections to ensure ongoing compliance of the originally certified product.

Report prepared for: Michael Shokrian (Intertek) on 8/20/2013 4:49:47 AM

Intertek AUTHORIZATION TO MARK

This authorizes the application of the Certification Mark(s) shown below to the models described in the Product(s) Covered section when made in accordance with the conditions set forth in the Certification Agreement and Listing Report(s). This authorization also applies to the Multiple Listee model(s) identified on the correlation page of the Listing Report. This document is the property of Intertek Testing Services and is not transferable. The Certification Mark(s) may be applied only at the location of the Party Authorized to Apply Mark.

Applicant: Knauf LLC
Knauf Head Office, 51b Zamaradah Building, Karama
P.O. Box 112871
Dubai

Country: United Arab Emirates

Contact: Amer Bin Ahmed

Phone:

Fax:

Email: binahmed.amer@knauf.de

Party Authorized to Apply Mark: Intertek (Elmendorf)

Evaluation Center: Intertek (Elmendorf)

Control/Client Number: 228254

Authorized By:
Thomas J. Patterson, Director of Certifications

Intertek Testing Services P.A., Inc.
3415 E. Algonquin Road, 3rd Fl., Arlington Heights, IL 60004 USA
Phone 847.433.7807 Fax 847.433.7333

Intertek

This document supersedes all previous Authorizations to Mark for the noted Report.

This Authorization to Mark is for the exclusive use of Intertek's Client and is provided pursuant to the Certification agreement between Intertek and the Client. Intertek's responsibility and liability are limited to the terms and conditions of the agreement. Intertek assumes no liability to any party other than the Client in accordance with the agreement. For any loss, expense or damage occasioned by the use of the Authorization to Mark, Only the Client is authorized to permit copying or distribution of the Authorization to Mark and then only in the entirety. Use of Intertek's Certification mark is restricted to the conditions listed in the agreement and the Authorization to Mark. Any further use of the Intertek name for the sale or advertisement of the listed material, product or service must first be approved in writing by Intertek. Initial Factory Assessments and Follow-up Services are for the purpose of assuring appropriate usage of the Certification mark in accordance with the agreement. They are not for the purpose of production quality control and do not relieve the Client of their obligations in this respect.

Testing Standard(s): ASTM E 1966 (2007)/ASTM C1396 / C1396M (2009)

Product: Knauf Gypsum Boards

ATM for Report G10986881; G109893201; G101095074 **ATM Issue Date: 08/20/2013**

Knauf LLC | 29665 | Rev: May 22 2013 2:21PM | Uncontrolled Copy Page 1 of 9

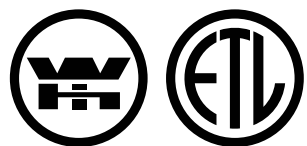

Intertek

KNAUF



Knauf Head Office

- ▶ Phone: +971 4 337 7170
- ▶ Fax: +971 4 334 9659
- ▶ P.O.Box: 112871, Dubai
- ▶ info@knauf.ae

www.Knauf.ae

Knauf Manufacturing Plant

P.O.Box 50006
Ras Al Khaimah, U.A.E.
Tel: +971 7 268 9837
Fax: +971 7 221 5301

Knauf Gypsum India Pvt.Ltd

No. 8 - C, 8th Floor Commercial Complex
Doshi Tower, New No. 205, (Old No.156)
Poonamallee High Road,
Kilpauk Chennai - 600010
Tamil Nadu, India
Tel: +91 44 49580000
Fax: +91 44 49575300

Disclaimer:

The information provided in this leaflet is only intended to give guidance in selecting and using Knauf products. While we make every effort to ensure its accuracy, neither Knauf LLC and its branches nor any of its employees or affiliates warrant or assume any legal liability or responsibility for the completeness or usefulness of any failure in installation or constructing any structure installation or building or caused by using this leaflet. Readers are advised to independently verify this information prior to rely on it. In particular, readers must obtain appropriate independent advice on the use in specific structures, insllations or buildings to ensure compliance with all regulations, including health and safety regulations. Knauf reserves the right to amend technical specification.

The constructional and structural properties, and characteristic building physics Knauf system can solely beensured with the exclusive use Knauf system components, or other product expressly recommended by Knauf.